

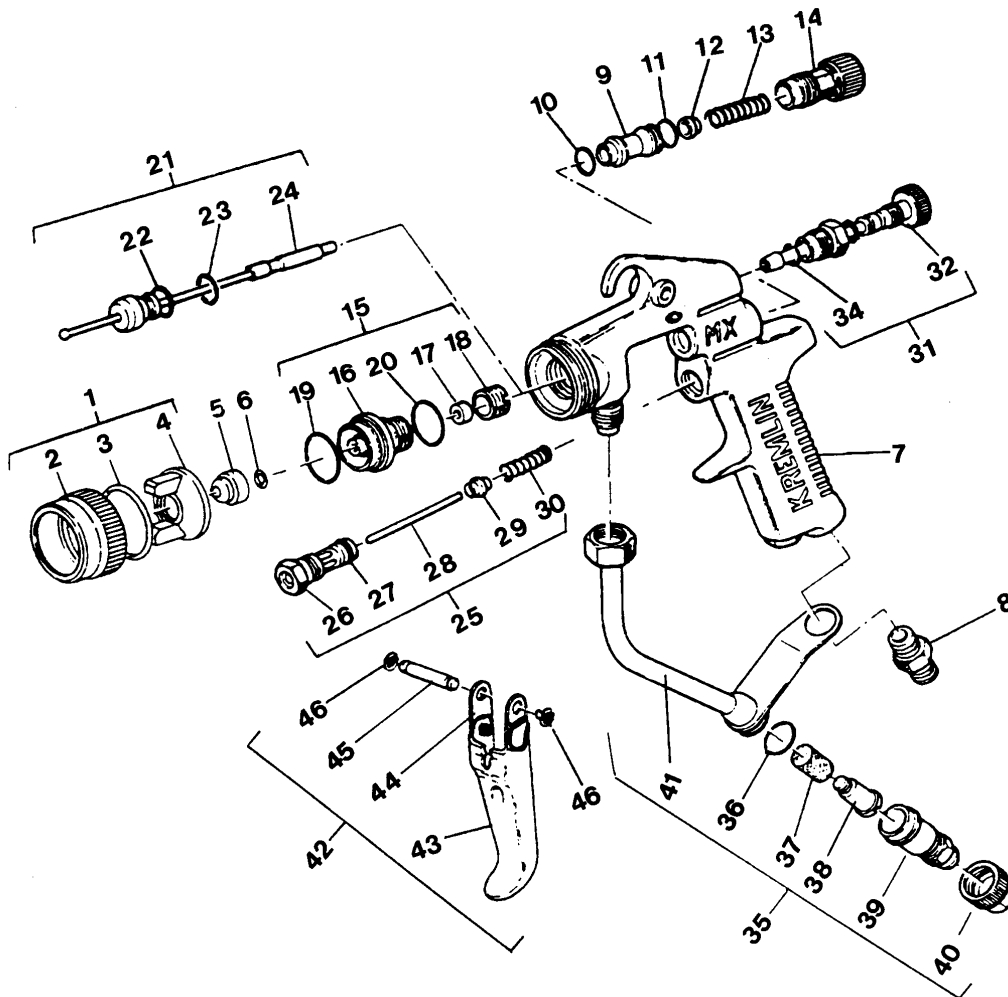





<p>Doc. 573.290.050 Date/Datum/Fecha : 15/01/03 Annule/Cancel/Ersetzt/Anula : 12/11/02</p>	<p>Modif. /Änderung : Tableau des buses / tip chart / Düsentabelle / cuadro de boquillas</p>	<p>Pièces de rechange Spare parts list Ersatzteilliste Piezas de repuesto</p>
------------------------------------------------------------------------------------------------------------------------------------------	-----------------------------------------------------------------------------------------------------	--------------------------------------------------------------------------------------------------------------------------

<p>PISTOLET AIRMIX ®, type MX LT (sans tête, ni buse)</p>	<p>AIRMIX ® GUN, Model MX LT (without aircap or tip)</p>
<p>AIRMIX ® PISTOLE, Modell MX LT (ohne Zerstäuberkopf, ohne Düse)</p>	<p>PISTOLA AIRMIX ®, tipo MX LT (sin cabezal, ni boquilla)</p>

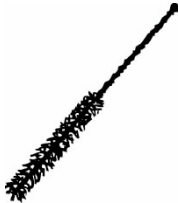

<p>Ind. 50</p> 	<p>Ind. 51</p> 	<p>Ind. 52</p> 
----------------------------------------------------------------------------------------------------	----------------------------------------------------------------------------------------------------	------------------------------------------------------------------------------------------------------

PISTOLET AIRMIX® (sans tête, ni buse)	AIRMIX® GUN (without aircap or tip)
AIRMIX® PISTOLE (ohne Zerstäuberkopf, ohne Düse)	PISTOLA AIRMIX® (sin cabezal, ni boquilla)

MX 90 LT	MX 120 LT	MX 200 LT
# 129.650.110	# 129.650.150	# 129.651.100

PIECES DE RECHANGE – PARTS IDENTIFICATION LIST – ERSATZTEILLISTE – PIEZAS DE REPUESTO

Ind	#	Désignation	Description	Bezeichnung	Denominación	Qté
* 1	-	Tête complète (voir accessoires)	Aircap assembly (refer to accessories)	Zerstäuberkopf kpl. (siehe Zubehör)	Cabezal completo (consultar accesorios)	1
2	032.020.001	• Bague de tête	• Aircap ring	• Überwurfring	• Anillo del cabezal	1
3	150.040.309	• Joint de bague (les 10)	• Seal, ring (pack of 10)	• O-Ring (10 St.)	• Junta del anillo (x 10)	1
4	NCS / NSS	• Tête nue	• Aircap only	• Zerstäuberkopf	• Cabezal solo	1
* 5	-	Buse à pion (voir accessoires)	Grooved Tip (refer to accessories)	Düse kpl. mit Kerbe (siehe Zubehör)	Boquilla con encaste tipo media luna (consultar accesorios)	1
* 6a	129.609.901	Micro-tamis (les 10) (voir accessoires)	Microfilter (pack of 10) (refer to accessories)	Mikrosieb (10 St.) (siehe Zubehör)	Micro-tamiz (x 10) (consultar accesorios)	1
* 6b	129.529.903	Joint de buse (les 10) (voir accessoires)	Seal, tip (pack of 10) (refer to accessories)	O-Ring, Düse (10 St.) (siehe Zubehör)	Junta de boquilla (x 10) (consultar accesorios)	1
7	129.650.040	Corps pistolet en inox	Gun body, stainless steel	Pistolenkörper, Edelstahl	Cuerpo pistola inox	1
8	050.102.624	Raccord M 1/4 NPS (arrivée d'air)	Connector, air inlet, M 1/4 NPS	Doppelnippel M 1/4 NPS	Racor M 1/4 NPS	1
9	029.650.001	Fourreau	Sleeve, fluid needle stop	Nadelführung	Vaina	1
10	129.029.903	Joint de fourreau (les 10)	Seal, sleeve (pack of 10)	O-Ring, nadelführung (10 St.)	Junta de vaina (bolsa de 10)	1
11	144.579.923	Bague R 8 bis (les 10)	Ring, R 8 bis (pack of 10)	O-Ring R 8 bis (10 St.)	Anillo R 8 bis (x 10)	1
12.. 20	-	<i>Voir page 4</i>	<i>Refer to page n°4</i>	<i>Siehe Seite Nr 4</i>	<i>Consultar página 4</i>	
* 21	129.620.900	Ligne pointeau-cartouche	Cartridge assembly	Farbnadel mit Packung	Conjunto aguja cartucho	1
22	129.400.915	• Joint de cartouche R5A en FPM (élastomères fluorés) (les 10)	• Seal, cartridge, R5A FPM (fluorous elastomers) (pack of 10)	• O-Ring R 5A FPM (Elastomer aus Fluor) (10 St.)	• Junta de cartucho R5A, FPM (elastómeros fluorados) (Bolsa de 10)	1
23	102.201.914	• Circlips Ø 10 (les 10)	• Circlip, Ø 10 (pack of 10)	• Sicherungsring Ø 10 (10 St.)	• Circlips Ø 10 (Bolsa de 10)	1
24	NCS / NSS	• Cartouche	• Cartridge	• Packung	• Cartucho	1

Ind	#	Désignation	Description	Bezeichnung	Denominación	Qté
25	129.650.050	Soupape d'air complète	Air valve assembly	Luftventil kpl.	Válvula de aire completa	1
26	NCS / NSS	• Siège de soupape	• Seat, air valve	• Luftventilsitz	• Asiento de válvula	1
27	150.040.322	• Joint (les 10)	• Seal (pack of 10)	• O-Ring (10 St.)	• Junta (bolsa de 10)	1
28	0.29.650.051	• Tige de soupape	• Rod, valve	• Luftventilstange	• Eje de válvula	1
* 29	129.739.910	• Soupape (les 10)	• Valve (pack of 10)	• Ventil (10 St.)	• Válvula (bolsa de 10)	1
30	050.311.221	• Ressort	• Spring	• Ventilfeder	• Muelle	1
31	129.080.030	Pointeau d'air assemblé	Air adjuster assembly	Spritzstrahlreguliertventil	Aguja de aire montada	2
32	NCS / NSS	• Pointeau air seul	• Needle	• Nadel	• Aguja de aire sola	1
34	902.202.102	• Circlips Ø 6	• Ring, Ø 6	• Sicherungsring Ø 6	• Circlips Ø 6	1
35	029.650.030	Tube produit avec filtre	Fluid protective tube with filter	Farbrohr mit filter	Tubo producto con filtro	1
36	129.529.918	• Joint (les 10)	• Seal (pack of 10)	• Dichtring (10 St.)	• Junta (bolsa de 10)	1
* 37	129.609.908	• Tamis de 6 (les 5)	• Screen, N° 6 (x 5)	• Sieb, Grösse 6 (5 St.)	• Tamiz de 6 (x 5)	1
38	029.520.310	• Support tamis	• Support, screen	• Stützschaube für Sieb	• Soporte tamiz	1
39	029.520.372	• Corps de filtre	• Filter body	• Filterkörper	• Cuerpo de filtro	1
40	029.520.306	• Ecrou	• Knurled nut	• Überwurfmutter	• Tuerca	1
41	NCS / NSS	• Tube produit	• Protective tube	• Farbrohr	• Tubo producto	1
* 42	129.651.020	Gâchette complète	Trigger assembly	Abzugshebel, komplett	Gatillo completo	1
43	029.651.001	• Gâchette	• Trigger	• Abzugshebel	• Gatillo	1
44	029.651.002	• Bretelle	• Strap	• Gelenkstange	• Tirante gatillo	2
45	029.651.005	• Axe de gâchette	• Spindle, trigger	• Abzugshebelachse	• Eje de gatillo	1
46	934.011.143	• Vis HM 5x10 inox	• Screw, stainless steel, HM 5x10	• Schraube HM 5x10 Edelstahl	• Tornillo HM 5x10 inox	2

50	049.030.021	Clé plate KREMLIN	KREMLIN gun wrench	Pistolenschlüssel	Llave para pistola	1
51	906.300.101	Goupillon	Large size brush	Pistolenreinigungsbürste	Cepillo grande	1
52	049.030.025	Clé (pour serrage du porte-siège)	Wrench (for seat-holder)	Schlüssel (zum Festschrauben des Düsenadelsitzes)	Llave (para el porta asiento)	1

*	129.659.902	Pochette de maintenance "air" (ind. 25, 31)	"Air" servicing kit (ind. 25, 31)	Luftventilsatz (Pos. 25, 31)	Bolsa de reparación "de aire"(ind. 25, 31)	1
*	129.659.901	Pochette de joints (ind. 3, 10, 11, 19, 20, 22, 23, 27, 29, 34, 36) (3 exemplaires de chaque)	Package of seals (ind. 3, 10, 11, 19, 20, 22, 23, 27, 29, 34, 36) (3 seals of each)	Dichtungssatz (Pos. 3, 10, 11, 19, 20, 22, 23, 27, 29, 34, 36) (3 Stück von jeder Position)	Bolsa de juntas (ind. 3, 10, 11, 19, 20, 22, 23, 27, 29, 34, 36) (3 ejemplares de cada uno)	1

* Pièces de maintenance préconisées tenues en stock
 * Preceding the index number denotes a suggested spare part.
 * Bezeichnete Teile sind empfohlene Ersatzteile.
 * Piezas de mantenimiento preventivo a tener en stock.

N C S : Non commercialisé seul.
 N S S : Denotes parts are not serviceable separately.
 N S S : Bezeichnete Teile gibt es nicht einzeln, sondern nur komplett.
 N C S : no suministrado por separado.

MX 90 LT : PIECES SPECIFIQUES - SPECIFIC PARTS - SPEZIFISCHE TEILE - PARTES ESPECIFICAS

Ind	#	Désignation	Description	Bezeichnung	Denominación	Qté
12	029.620.021	Appui ressort	Spring support	Federführung	Soporte muelle	1
* 13	050.312.221	Ressort de pointeau	Spring, fluid needle	Farbnadelfeder	Muelle de aguja	1
14	129.650.010	Butée de pointeau (90 bar)	Fluid needle stop (90 bar / 1305 psi)	Blockierschraube (90 bar)	Tope de aguja (90 bar)	1
* 15	129.622.100	Porte-siège assemblé	Seat-holder assembly	Düsennadelsitz, komplett	Porta-asiento montado	1
16	029.620.501	• Porte-siège	• Seat-holder	• Düsennadelsitz	• Porta-asiento	1
* 17	129.609.911	• Siège en résine acétale (les 10)	• Seat, acetal resin (pack of 10)	• Sitz in Acetalharz (10 St.)	• Asiento de resina acetato (bolsa de 10)	1
18	029.600.106	• Vis	• Screw	• Schraube	• Tornillo	1
19	129.609.902	• Joint du porte-siège (les 10)	• Seal, seat-holder (pack of 10)	• Dichtung (10 St.)	• Junta porta-asiento (bolsa de 10)	1
20	129.629.914	• Joint torique (les 10)	• O-Ring (pack of 10)	• O-Ring (10 St.)	• Junta torica (x 10)	1

MX 120 LT : PIECES SPECIFIQUES - SPECIFIC PARTS - SPEZIFISCHE TEILE - PARTES ESPECIFICAS

Ind	#	Désignation	Description	Bezeichnung	Denominación	Qté
12	029.620.021	Appui ressort	Spring support	Federführung	Soporte muelle	1
* 13	050.312.221	Ressort de pointeau	Spring, fluid needle	Farbnadelfeder	Muelle de aguja	1
14	129.650.155	Butée de pointeau (120 bar)	Fluid needle stop (120 bar / 1740 psi)	Blockierschraube (120 bar)	Tope de aguja (120 bar)	1
* 15	129.626.400	Porte-siège assemblé	Seat-holder assembly	Düsennadelsitz, komplett	Porta-asiento montado	1
16	029.620.501	• Porte-siège	• Seat-holder	• Düsennadelsitz	• Porta-asiento	1
* 17	129.629.923	• Siège inox avec joint (les 2)	• Seat with seal, stainless steel (pack of 2)	• Edelstahl-Einsatz, mit Dichtung (2 St.)	• Asiento inox con junta (bolsa de 2)	1
-	NCS / NSS	- Siège inox seul	- Seat, stainless steel	- Sitz, Edelstahl	- Asiento inox solo	1
-	129.629.922	- Joint de siège (les 10)	- Seal, seat (pack of 10)	- Sitzdichtung (10 St.)	- Junta de asiento (x 10)	1
18	029.600.106	• Vis	• Screw	• Schraube	• Tornillo	1
19	129.609.902	• Joint du porte-siège (les 10)	• Seal, seat-holder (pack of 10)	• Dichtung (10 St.)	• Junta porta-asiento (bolsa de 10)	1
20	129.629.914	• Joint torique (les 10)	• O-Ring (pack of 10)	• O-Ring (10 St.)	• Junta torica (x 10)	1

MX 200 LT : PIECES SPECIFIQUES - SPECIFIC PARTS - SPEZIFISCHE TEILE - PARTES ESPECIFICAS

Ind	#	Désignation	Description	Bezeichnung	Denominación	Qté
12	029.651.004	Appui ressort	Spring support	Federführung	Soporte muelle	1
* 13	050.313.205	Ressort de pointeau	Spring, fluid needle	Farbnadelfeder	Muelle de aguja	1
14	129.651.010	Butée de pointeau (200 bar)	Fluid needle stop (200 bar / 2900 psi)	Blockierschraube (200 bar)	Tope de aguja (200 bar)	1
* 15	129.626.400	Porte-siège assemblé	Seat-holder assembly	Düsennadelsitz, komplett	Porta-asiento montado	1

ACCESSOIRES - ACCESSORIES - ZUBEHÖR - ACCESORIOS

TETES - AIRCAP - DÜSENKÖPFE - CABEZALES (ind. 1)

	#	Utilisation	Use	Benutzung	Utilización
BX 16	132.620.026	Largeur de jet réglable et grande possibilité de réglage de débit.	For adjustable pattern width - Adjustable flow rate.	Einstellbare Spritzstrahlbreite, regulierbare Ausbringmenge.	Anchura de abanico regulable y grande posibilidad de regulacion de caudal
BX 36	132.650.200	Largeur de jet fixe.	For permanent pattern width.	Feste Spritzstrahlbreite.	Anchura de abanico fija.
BX 56	132.650.300	Largeur de jet fixe - Tête traitée anti-adhérent.	For permanent pattern width - antiadherent treatment.	Feste Spritzstrahlbreite - antihafbeschichteter Düsenkopf..	Anchura de abanico fija - Cabezal tratado anti-adherente.
BX 86	132.650.100	Largeur de jet réglable.	For adjustable pattern width.	Einstellbare Spritzstrahlbreite.	Anchura de abanico regulable.

TABLEAU DES BUSES - TIP CHART - DÜSENTABELLE - CUADRO DE BOQUILLAS (ind. 5) (Buses en inox / Tips, stainless steel / Edelstahldüsen / Boquillas de inox)

 Calibre Size Größe		Débit d'eau Water output Wasserdurchlaufmenge		Repères tamis pour filtre Mesh number for filter Siebgröße für filter Índices para filtro		Largeur de jet à 25 cm / Spray fan width at 25 cm (10 ") Strahlbreite bei 25 cm / Ancho abanico à 25 cm									
		Caudal agua (l / mn)		Pistolet Gun Pistole Pistola / Pompe Pump Pumpe Bomba		Mini (cm) Mini (")	7 2.8	10 4	13 5.3	17 6.7	21 8	25 10	29 12	33 13	38 15
Ø. (mm)	35 bar (500 psi)	70 bar (1000 psi)				Maxi (cm) Maxi (")	9 3.5	12 4.7	17 6.7	21 8	25 10	29 12	33 13	37 14.5	44 17.3
02						Nombre gravé sur la buse	02.034	02.054							
03	0,18	0,10	0,15	4	2		03.034	03.054	03.074						
04	0,23	0,15	0,22	4	2 ou 4		04.034	04.054	04.074	04.094	04.114				
06	0,28	0,20	0,33	4	4 ou 6	Number engraved on the tip	06.034	06.054	06.074	06.094	06.114	06.134	06.154		
09	0,33	0,30	0,45	6	6 ou 8		09.034	09.054	09.074	09.094	09.114	09.134	09.154		
12	0,38	0,35	0,60	6	8 ou 12				12.074	12.094	12.114	12.134	12.154	12.174	
14	0,41	0,40	0,72	12	8 ou 12	Eingravierte Kennzahl auf der Düse	14.034	14.054	14.074	14.094	14.114	14.134	14.154	14.174	
18	0,48	0,45	0,85	12	12							18.134	18.154	18.174	
20	0,50	0,50	1,06	12	12				20.074	20.094	20.114	20.134	20.154	20.174	20.194
25	0,56		1,33	12	15	Número índice gravado sobre la boquilla						25.134			
30	0,61	0,75	1,60	12	15				30.074		30.114	30.134	30.154	30.174	30.194
45	0,73	1,15	2,30	12	20						45.114		45.154	45.174	45.194



Pour établir la référence d'une buse, remplacer les croix par le nombre repère de la buse précédé de 134.5XX.XXX
Exemple : pour commander une buse 09.094, utiliser la référence : 134.509.094

To obtain tip part number, replace the crosses by the engraved tip number preceded by 134.5XX.XXX
Example : use part number 134.509.094 to obtain TIP N° 09.094

Die Bestell-Nr. erhält man, indem man die Kreuze durch die vorgenannte Kennzahl ersetzt : 134.5XX.XXX
Beispiel : für eine Düse 09.094 ergibt sich die Bestell-Nr. : 134.509.094

Para establecer la referencia de una boquilla reemplazar las cruces por el número de la boquilla precedido por 134.5XX.XXX
ejemplo : para pedir una boquilla 09.094 emplear la referencia : 134.509.094

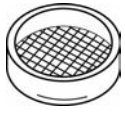

JOINT ET MICRO-TAMIS DE BUSE - TIP MICROFILTER AND SEAL - DÜSENDICHTUNGEN UND MIKROSIEB - JUNTA Y MICROTAMIZ DE BOQUILLA

Ind.		#	Désignation	Description	Bezeichnung	Denominación
6a		129.609.901	Micro-tamis 100 µ (les 10) - Seulement pour buses 03, 04 et 06	Microfilter 100 µ (pack of 10) - Only for tips size 03, 04 and 06	Micro-Sieb 100 µ (10 St.) - Nur für Düsentyp 03, 04 und 06	Micro-tamiz 100 µ (bolsa de 10) - Solo para boquillas 03, 04 y 06
6b		129.529.903	Joint PTFE (les 10) - Seulement pour buse de 09 et calibre supérieur	PTFE seal (pack of 10) - Only for tips size 09 and above	PTFE-Düsendichtungen (10 St.) - Nur für Düsentyp 09 und grösser	Junta PTFE (bolsa de 10) - Solo para boquilla de 09 y calibre superior

FILTRE A LA CROSSE - GUN FILTER - SIEB FÜR PISTOLENFILTER - FILTRO A LA EMPUÑADURA (x 5)

Ind.	#	Tamis - Screen - Sieb - Tamiz N°	Calibre - Mesh - Feinheit	Buse - Tip - Düse - Boquilla
37	129.609.907	4	99 µ	03 - 04 - 06
37	129.609.908	6	168 µ	09 - 12
37	129.609.909	12	280 µ	14 - 18 -

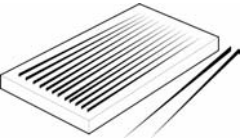
OPTIONS - ON REQUEST - OPTIONEN - OPCIONES

Ind.	#	Désignation	Description	Bezeichnung	Denominación
17	129.609.911	Siège en résine acétale (les 10)	Seat, acetal resin (pack of 10)	Sitz in Acetalharz (10 St.)	Asiento de resina acetabo (bolsa de 10)
17	129.629.923	Siège en inox avec joint (les 2)	Seat with seal, stainless steel (pack of 2)	Edelstahl-Einsatz, mit Dichtung (2 St.)	Asiento inox con junta (bolsa de 2)
17	129.659.904	Siège en carbure avec joint (les 2)	Seat with seal, carbide (pack of 2)	Nadelsitz aus Hartmetall und Dichtring (2 St.)	Asiento carburo con junta (bolsa de 2)
22	129.400.901	Joint de cartouche en EPDM (les 10) pour produits : acétone, MEK...	EPDM seal, cartridge (pack of 10) for fluid : cetone, MEK...	O-Ring, packung aus EPDM (10 St.) für Material : Ketone, MEK ...	Junta de cartucho de EPDM (bolsa de 10) para productos ; acetona, MEK ...
		Aiguilles de débouchage (x 12) pour buses :	Unclogging needles (pack of 12) for tips :	Düsenreinigungsna-deln (12 St.) für Dü-sen :	Agujas desobturadoras (bolsa de 12) para boquillas :
	000.094.000	de 03 à 09	size 03 to 09	von 03 to 09	de 03 a 09
	000.094.002	de 12 à 30	size 12 to 30	von 12 to 30	de 12 a 30
	075.800.001	Allonge droite long. 250 mm	10" Extension, straight	Verlängerung 250 mm gerade	Prolongador 250 mm, lateral
	075.800.002	Allonge droite long. 400 mm	16" Extension, straight	Verlängerung 400 mm gerade	Prolongador 400 mm, lateral
	075.850.001	Allonge coudée 45°, long. 250 mm	10" Extension with 45 degree swivel	Verlängerung 250 mm gerade, Kopf 45° abgewinkelt	Prolongador 250 mm, codo a 45°