



INSTRUCTION MANUAL

SHOVEL FLUID SECTIONS

225 cc / 7.6 oz

105 886 xx xx

Manual : 574.218.112 - 0704

Date : 23/04/07 - Supersede : 07/09/06

Modif. : + # 105 886 0310

IMPORTANT : Read and understand all instructions before storing, installing and operating concerned equipment (professional use only).

PICTURES AND DRAWINGS ARE NOT CONTRACTUAL. THE MATERIAL MAY BE CHANGED WITHOUT PRIOR NOTICE.

**KREMLIN REXSON – Site de Stains : 150, avenue de Stalingrad
93 245 - STAINS CEDEX - FRANCE
Téléphone : 33 (0)1 49 40 25 25 - Fax : 33 (0)1 48 26 07 16**



**INSTRUCTION MANUAL
SHOVEL FLUID SECTIONS**

SUMMARY

1. INCORPORATION DECLARATION	2
2. WARRANTY	2
3. SAFETY INSTRUCTIONS	3
4. INSTALLATION	6
5. OPERATING	7
6. USE	7
7. MAINTENANCE	10
8. SPECIFICATIONS	11
9. DISASSEMBLY / ASSEMBLY	11
10. EXPLODED VIEW & SPARE PARTS' LIST	14

Dear Customer,

You are the owner of our new equipment and we would like to take this opportunity to thank you.

To make sure your investment will provide full satisfaction, special care has been taken by KREMLIN REXSON during all designing and manufacturing processes.

To obtain the best result, safe and efficient operation of your equipment, we advice you to read and make yourself familiar with this instruction and service manual. Indeed, the non-compliance with instructions and precautions stated in this manual could reduce the equipment working life, result in operating trouble and create unsafe conditions.

1. INCORPORATION DECLARATION

The manufacturer : **KREMLIN REXSON** with assets of 6 720 000 Euros

Head office : 150, avenue de Stalingrad 93 245 - STAINS CEDEX - FRANCE

Tel. 33 (0)1 49 40 25 25 - Fax : 33 (0)1 48 26 07 16

Herewith declares that :

<i>Description</i>	<i>SHOVEL FLUID SECTION</i>
<i>Equipment number</i>	<i>105 886 xx xx</i>
<i>Trademark</i>	<i>KREMLIN REXSON</i>

Could not be used before the equipment with which it will be incorporated is declared in conformity with the : Machinery Directive (Directive 98/37/EEC) as amended and with national implementing legislation.

ATEX Directive (Directive 94/9/EEC):  II 2 G (group II, class 2, gas).

Established in Stains, on October 5th 2005

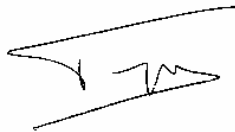

Daniel TRAGUS
President

2. WARRANTY

We reserve the right to make changes; these changes may be carried out after the receipt of our order. No claim will be accepted as a consequence of any change carried out in the instruction manuals or in the selection guides.

Our equipment is checked and tested prior to shipment. In the case of a problem arising with the equipment, this must be in writing, within ten days from the delivery date.

KREMLIN REXSON warrants all equipment manufactured bearing its name, to be free from defect in material or workmanship for a period of 12 months (one shift per day or 1800 hours - 1 term reached) from the date of delivery. Work life is based on single shift working - 8 hours per day. Warranty claims for defective items will only be accepted in writing and will be verified and confirmed by us.

The warranty does not cover fair wear tear, damage or wear caused by misuse, improper maintenance or non-observance of our recommendations.

KREMLIN REXSON will repair or replace parts (carriage paid to our plant and accepted as defective by us). We shall not be liable for any losses, resulting from a production breakdown. Upon request, we can carry out service work at your premises; all expenses (travelling and accommodation) for KREMLIN REXSON technicians will be chargeable.

In the event that it is found that equipment has been tampered with, this will invalidate the warranty. Equipment that is bought in will be subject to the supplier's warranty.

3. SAFETY INSTRUCTIONS

GENERAL SAFETY INSTRUCTIONS



CAUTION : The equipment can be dangerous if you do not use it according to the rules mentioned in this instruction manual. Read carefully all the instructions hereafter before operating your equipment.

Only trained operators can use the equipment. (To acquire an essential training, please contact the "KREMLIN REXSON University" training center - Stains).

The foreman must ensure that the operator has perfectly taken in the safety instructions of this equipment as well as the instructions in the manuals of the different parts and accessories.

Read carefully all instruction manuals, label markings before operating the equipment.

Incorrect use may result in injury. This equipment is for professional use only. It must be used only for what it has been designed for. Never modify the equipment. The parts and accessories supplied must be regularly inspected. Defective or worn parts must be replaced.

Never exceed the equipment components' maximum working pressure.

Comply with regulations concerning safety, fire risks, electricity in force in the country of final destination of the material. Use only products or solvent compatible with the parts in contact with the material (refer to data sheet of the material manufacturer).

PICTOGRAMS

NIP HAZARD	WARNING MOVING ELEVATOR	WARNING MOVING PARTS	WARNING MOVING SHOVEL	DO NOT EXCEED THIS PRESSURE	HIGH PRESSURE HAZARD
RELIEF OR DRAIN VALVE	WARNING HOSE UNDER PRESSURE	WEAR GLASSES OBLIGATORY	WEAR OF GLOVE IS OBLIGATORY	PRODUCT VAPOR HAZARDS	WARNING HOT PARTS OR AREAS
ELECTRICAL HAZARD	WARNING FIRE HAZARDS	EXPLOSION HAZARDS	GROUNDING	WARNING (USER)	WARNING SERIOUS INJURIES

PRESSURE HAZARDS



Current legislation requires that an **air relief** shut off valve is mounted on the supply circuit of the pump motor to let air off when closing the supply circuit. Without this precaution, the motor residual air of the motor may let the pump beat and cause a serious injury.

Please ensure that, a **material drain valve** is mounted on the material circuit to drain it (after shutting down air to the motor and the pressure relief) before any servicing on the equipment. These valves must be closed for air and opened for product when processing.

HIGH PRESSURE INJECTION HAZARDS



When working with high pressure equipment, special care is required. Fluid leaks can occur. Then there are injection risks in exposed parts of body that may cause severe injuries or amputations :

- Medical care must be handled immediately if product is injected under the skin or in other parts of the body (eyes, fingers).
- Never point the spray gun at any one. Never try to stop the spray with your hands or fingers nor with rags or similars.
- **Follow the shut down procedure and always depressurize air and fluid circuits** before carrying out any servicing on the gun (cleaning, checking, maintenance of the material or cleaning of the gun nozzles).



For the guns equipped with a safety device, always lock the trigger when you do not start the gun.

FIRE - EXPLOSION - SPARKS - STATIC ELECTRICITY HAZARDS



A poor earth connection, inadequate ventilation, sparks or static electricity can cause an explosion or fire. to avoid these risks when using or servicing KREMLIN REXSON equipment, the following safety procedures must be followed :



- ensure a good earth connection and ground the parts to be handled i.e. solvents, materials, components and equipment,
- ensure adequate ventilation,
- keep working area clean and free from waste solvents, chemicals, or solid waste i.e. rags, paper and empty chemicals drums,
- never use electrical switches / power if in an atmosphere of volatile solvent vapour,
- stop working immediately in case of electrical arcs,
- never store chemicals and solvents in the working area.



TOXIC PRODUCT HAZARDS

Toxic products or vapours can cause severe injury not only through contact with the body, but also if the products are ingested or inhaled. It is imperative :



- to know the material products and their risks,
- notified or hazardous materials must be stored in accordance with the regulations,
- the material must be stored in an appropriate container, never place materials in a container where there is a risk of spillage or leakage,
- a procedure must be applied for the safe disposal of waste material. It must comply with all prevailing regulations and legislations of the country where the equipment is to be used,
- protective clothing should always be worn in compliance with the material manufacturers' recommendations,
- depending on the application and chemical safety instructions, safety glasses, gloves, foot wear, protective masks and possible breathing equipment should be worn to comply with the regulations

(Refer to chapter "Safety equipment of KREMLIN selection guide).



CAUTION!

It is forbidden using any solvent or with halogenated hydrocarbon base and also products with these solvents facing **aluminium** or **zinc**. The non-compliance with the instructions may cause explosion hazards causing serious or fatal injuries.

EQUIPMENT REQUIREMENTS

PUMP

Before carrying out any work, it is imperative to get used with the compatibilities of motors with pumps before coupling. The operator shall understand the equipment and the safety instructions. These instructions are available in the manuals of the pumps.

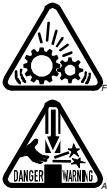

The air motor is designed to be mounted with a pump. Never modify any components or couplings. Where operating, please keep hands away from moving parts. Before starting up the equipment, please read the PRESSURE RELIEF instructions. Please ensure that any relief or drain valves fitted are in good working order.

HOSES

- Keep hoses out of circulation areas, moving parts or hot surfaces,
- Never expose product hoses to temperature higher than + 60°C / 140° F or lower than 0°C / 32° F,
- Never pull or use the hoses to move the equipment,
- Tighten all fittings as well as the hoses before operating the equipment,
- Check the hoses regularly; change them if they are damaged,
- Never exceed the working pressure (WP) indicated on the hose.

USED PRODUCTS

Considering the variety of products that may be used by the users and the impossibility to check off all chemical data, of possible reactions of chemicals to each other and their long term evolution, KREMLIN REXSON can not be considered as liable for :

- the bad compatibility of wetted parts,
- risks for staff and surroundings,
- for worn or out of order parts, for wrong working of equipments or units, as well as for the qualities of final product.

The user must know and prevent the possible risks as toxic vapours, fires or explosions due to used products. He shall determine the risks of immediate reactions or pursuant to repeated exposures of the staff,

KREMLIN REXSON shall not be liable for psychic injuries, direct or indirect material damages further to the use of chemicals.

4. INSTALLATION

■ HANDLING



The fluid sections with important weight and dimensions must be handled with the appropriate means.

■ STORAGE

Place the equipment safe from dampness after having closed the different air inlets and ports (plugs).

■ DESCRIPTION OF THE LABEL MARKING

Marking in accordance with the ATEX directive

	MOTEUR / MOTOR	POMPE / PUMP	MOTO-POMPE / MOTOR-PUMP
REF / SERIE	<input type="text"/>	<input type="text"/>	<input type="text"/>
○ Max.pres.(bar/psi)	<input type="text"/>	<input type="text"/>	<input type="text"/>
	<input type="text"/>		<input type="text"/>
	KREMLIN REXSON France		RATIO

KREMLIN REXSON FRANCE	Name and address of the manufacturer
MOTEUR / MOTOR	-
POMPE / PUMP	Motor part number and serial number
MOTO-POMPE / MOTOR-PUMP	-
 II 2 G CE	<p>II : group II 2 : class 2</p> <p>Surface equipment meant to area where explosive atmospheres due to gas, vapours, mists or air mixtures with dusts are liable to appear from time to time in usual operating.</p> <p>G : gas</p>



Associated to a pneumatic motor, the fluid sections must be grounded via the earth cable of that motor.

The earth cable must be grounded to a safe earth.

The pumps are designed to be installed in a spray booth.

■ CONNECTION OF THE SUBSETS

These fluid sections are designed for the coupling of pneumatic or hydraulic motors with similar stroke.
You must conform to a motor/pump association as planned by KREMLIN REXSON.

5. OPERATING

■ EXPECTED USE

These pumps coupled with pneumatic or hydraulic motors are designed for the transfer, the pouring off or the spraying of different liquid or viscous fluids with a requested outlet flow and pressure.

■ OPERATING DESCRIPTION

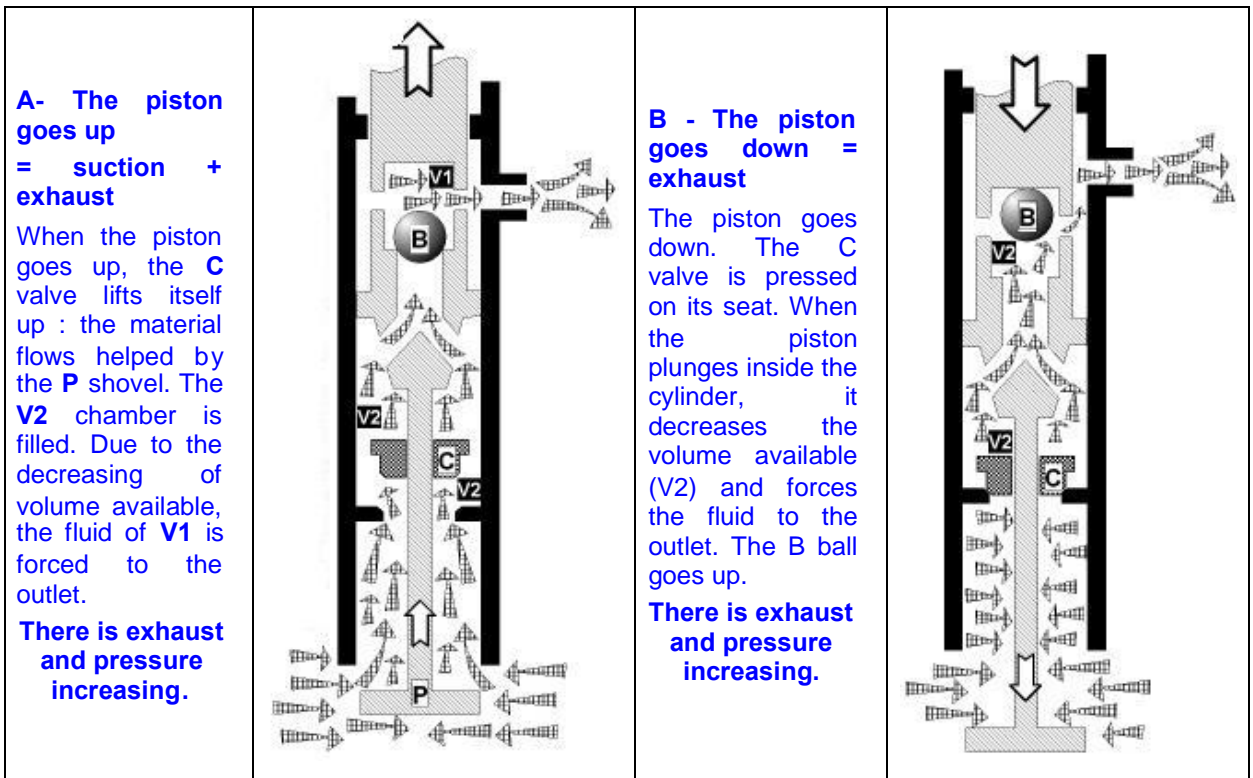

WARNING!

The frictions due to the displacement of fluid inside the pumps and accessories, as well as the one created by the tightness seals, generate static electricity that may cause fire or explosion. This is why the pump must be grounded (refer to § 2 and to the instruction manual of the motor for its grounding).

6. USE



Protective clothing (gloves, protective masks, glasses, protective clothing,...) should be worn to comply with the recommendations.

The working area must be correctly ventilated.

■ ADJUSTMENTS

Before starting the equipment, half fill the cup with T lubricant.

The cup nut must be slightly tightened. A too important tightening would damage the cup seals. A wrench is supplied to allow a correct tightening.

Tightening of the wetting cup

- Fill the cup with T lubricant,
- Start the pump, then tighten the cup after 10 minutes, then one hour and then one day of operating,
- If you notice a leakage, the cup must be tightened.

Tightening instructions :

- Depressurize the motor (refer to pressure relief instructions),
- Depressurize the fluid circuit (refer to pressure relief instructions),
- Tighten the cup, clean it and fill it with T lubricant,
- Close the pump drain circuits,
- Open the motor air valve.

■ START UP

The pumps are tested in our workshop with lubricant.

Before starting up, you must flush the pump with the appropriate solvent.

At the end of the working day, carry out a flushing with the appropriate solvent. We advice you to stop the pump in the "low position" to prevent material spreading on the piston rod.

■ TROUBLESHOOTINGS



Before any intervention on the pump, please carry out the release pressure and drain general instructions.

To prevent from injuries, material injections, injuries due to moving parts or sparks during the stopping of the system, the assembly, the cleaning or changing of the nozzle, **you must follow the stages hereafter** before intervening :

- Close the guns,
- Shut off the air inlet using the pressure release to evacuate the residual air.
- Move the gun near to a metallic drum to get back the fluid. Keep it against the drum to maintain the grounding (if necessary use a wire to ground the metallic drum).
- Open the gun to drain the circuit.
- Open the drain valve of the pump and get back the fluid in a metallic drum correctly grounded.
- Let the drain valve open during the intervention.

Check the conformity of cabling before intervening.

DEFECTS	CAUSES	SOLUTIONS
Leakage at the cup seals	Insufficient tightening of the cup. Bad mounting of the seals Damaged or worn seals. Bad choice of the seals' material	Screw the cup. Check the mounting Replace them. Check the compatibility.
The cup seals get rapidly damaged	No lubricant in the cup (pumped product drying on the piston rod). Compatibility product / seals.	Clean, replace parts if necessary. During a long duration shutdown, stop the pump, the piston is in the the low position. Check.
The pump is stopped	The fluid is polymerized, hardened, dried in the pump. The cup nut is too tightened. Broken part(s) in the pump.	Clean the pump; change parts if necessary. Unscrew. Remove, check and replace.
The motor seems to operate but the pump does not deliver product	Internal parts of the motor defective. Defective coupling.	Check the operating of the motor. Check coupling.
The pump operates but irregular flow	Valve clogged on the seat, incorrectly mounted or worn. Air inlet in the suction circuit.	Check mounting, state of the parts, tightening of parts and seals.
At stop, pump piston carries on going down	Valve worn or incorrectly mounted Plug or drain valve not tightened	Check and replace parts.
At stop, pump piston carries on going up	Head piston seals or upper valve worn or incorrectly mounted. Plug or drain valve not tightened	Check and replace parts.
The piston is going down quickly (simple effect working)	Bad feeding of the pump. Product is too viscous. Lower valve worn. A foreign product obstructs the lower valve.	Check use parameters of the accessories (pressure on follower plate or suction rod,...). Accessories can be not adapted or clogged. Bad definition of the pump. Check and replace parts. Clean and check.
The piston goes up quickly	Valve worn or damaged. A foreign product obstructs the upper valve.	Check and replace parts. Clean and check.
The piston goes out and down at different speeds	Valve, head piston seals or cylinder worn. Seals incorrectly mounted or damaged	Replace parts. Check the mounting; change if necessary.

DEFECTS	CAUSES	SOLUTIONS
The pump does not deliver enough pressure	<p>Insufficient air pressure to the motor (valve insufficiently open, air leak,...)</p> <p>Insufficient air inlet on the motor or outlet clogged.(hose not adapted)</p> <p>Cup or head piston seals too tightened.</p>	<p>Check; adjust.</p> <p>Check filter, mounting, hose not adapted.</p> <p>Check mounting or loosen cup nut.</p>
Abnormal operating after racing or too important temperature.	<p>Head piston or cup seals too tightened, damaged.</p> <p>Product drum empty.</p>	<p>Check mounting; reduce pumping rhythm. Replace parts if necessary.</p> <p>Fill the drum; check the suction circuit and possible air leakage.</p>

7. MAINTENANCE

	<p>WARNING!</p> <p>Before any intervention, please follow the pressure release instructions and read carefully the safety instructions.</p> <p>During a long duration shutdown, stop the pump when the piston is in low position.</p>
---	--

■ PREVENTIVE MAINTENANCE

Daily care :

Check if there are leaks. Check that the hoses are in good conditions.

Keep the piston of the pumps clean to prevent from material drying.

Check the PE level inside the shell (keep the level halfway up). Fill it if necessary. The lubricant will normally be coloured by the material.

Tighten moderately if necessary the cup nut with the wrench provided.

Check the tightening of the different parts.

If the pump is fitted with a follower plate : check that the plate seal is in good condition, clean top and bottom parts of the follower plate.

Manipulate (open and close) all the valves of the installation.

Keep the spray area clean.

Bimonthly care :

If the lubricant is excessively coloured in the cup, fill the cup with new lubricant. Leave the cup clean and clean it regularly with lubricant after having drained the lubricant.

■ CURATIVE MAINTENANCE

We advice you to schedule a systematic maintenance after a given working time. The rhythm is defined by the maintenance staff of the user and is done according to the product, the rate of work and the regular using pressure.

Before intervening on the equipment :

- Clean the parts with the appropriate cleaning solvent,
- Install new seals if necessary after having lubricated them,
- Lubricate the piston and the inside of the cylinder to prevent from damaging the seals,
- Install new parts if necessary.

8. SPECIFICATIONS

Capacity	112.5 cc / 3.8 oz
Delivery per cycle	225 cc / 7.6 oz
Nominal stroke	120 mm / 4.7"
Maximum stroke	132 mm / 5.2"
Fluid outlet connections	F 3/4 G
Plunger and hard chromium cylinder - thickness	From 0.08 mm to 0,12 mm / from 0.003 to 0.005 "
Ball valve on seat	Treated steel at 200 kg/mm ²
Foot-valves	Case hardened soaked HRc64
Foot-valve seat	Nitrided 0.3 mm / 0.02"
Upper wetting cup seals	PTFE G
Lower wetting cup seals	PA11
Piston seals	PTFE G
Weight	30 kg / 66 lbs

9. DISASSEMBLY / ASSEMBLY



WARNING!

Before any intervention, please follow the pressure relief and safety instructions.

Disassembly of the pump from the motor

- Stop the pump, in low or intermediate position,
- Shut off the motor air supply,
- **Carry out the pressure relief instructions,**
- Remove the elastic ring,
- Lift up the closing ring,
- Take off the two half bushes and the closing ring,
- **Remove the suction system (if there is one) and the pump outlet,**
- Unscrew the screws and put aside the pump.

Disassembly of the lower valve and of the lower cup - pumps # 105 886 0101 and 105 886 0202

- Unscrew the filling tube (22),
- Unscrew the lock nut (23A),
- Take off the shovel (23) and the nut (24),
- Unscrew the 4 nuts (25) and take off the washers (26),
- Take off the foot valve (21); check the seat and change the valve if necessary,
- Check the seal (17), change it if necessary,
- Unscrew the lower valve (27),
- Take off the first washer (18),
- Take off and check the 2 first seals (19), change them if necessary,
- Take off the spacer (20),
- Take off and check the 5 other seals (19), change them if necessary,
- Take off the second washer (18),

- Remove the cup nut (28),
- Take off the valve retaining ring (29).

Nota : If the lower body, corrected after handling, is damaged, change the body. When changing the body, you must change the valve and the ball.

Disassembly of the lower valve and of the lower cup- pump # 105 886 0310

- Remove the flange (44) and its rush (47), then unscrew the screws (45) and the adapter (43),
- Check and change the seal (46) if necessary,
- Unscrew the nut (23) and remove the washer (42),
- Take off the shovel (23), the valve (48) and the valve guide (41),
- Unscrew the 4 nuts (25), remove the washers (26),
- Take off the foot valve (21), check the seat and change the valve if necessary,
- Check the seals (40 & 7) and change them if necessary,
- Unscrew the lower valve (18) and take off the valve assembly,
- Remove the first washer (21),
- Remove and check the 2 first seals (19); change them if necessary,
- Take off the spacer (20),
- Remove and check the 5 other seals (19), change them if necessary,
- Remove the second washer (21),
- Take off the cup nut (11),
- Remove the valve retaining ring (22).

Nota : If the lower body, corrected after handling, is damaged, change the body. When changing the body, you must change the valve and the ball.

Disassembly of the upper valve and of the piston seals

- Take off the cylinder (16), check it and change it if necessary,
- Remove the pin (15),
- Unscrew the control rod (30),
- Unscrew the piston bush (31), check its seat and change the bush if necessary,
- Check the ball (32), change it if necessary,
- Take off the 'F' washer (14),
- Take off and check the 6 seals (13), change them if necessary,
- Take off the second 'M' washer (12).

Nota : If the seat of the piston bush, corrected after handling is damaged, change the seat holder. When changing the seat holder, you must change the ball and the valve body.

If the cylinder is damaged, when changing it, you must change the seals (13).

Disassembly of the piston and checking of the seals from the cup

- Remove the cup nut (3),
- Take off, check and change if necessary in the following order :
 - the 'F' washer (6),
 - the 12 seals (7),
 - the 'M' washer (8),
- Unscrew the coupling axis (36),
- Remove the piston (34),
- Take off and check the seal (17) from the pump body (33), change it if necessary.

Nota : If the plunger has scratches, you must change it as well as the seals (7).

Assembly

Reinstall the parts in the reverse order of the disassembly sequence.

The piston bush (31) and the piston (34) must be glued with 'Loctite 243' glue.

The piston (34) and the coupling axis (36) must be glued with 'Loctite 243' glue.

Before intervening on the equipment :

- **Clean the parts with the appropriate cleaning solvent,**
- **Install new seals if necessary after having lubricated them,**
- **Lubricate the piston and the inside of the cylinder to prevent from damaging the seals,**
- **Install new parts if necessary.**

10. EXPLODED VIEW & SPARE PARTS' LIST

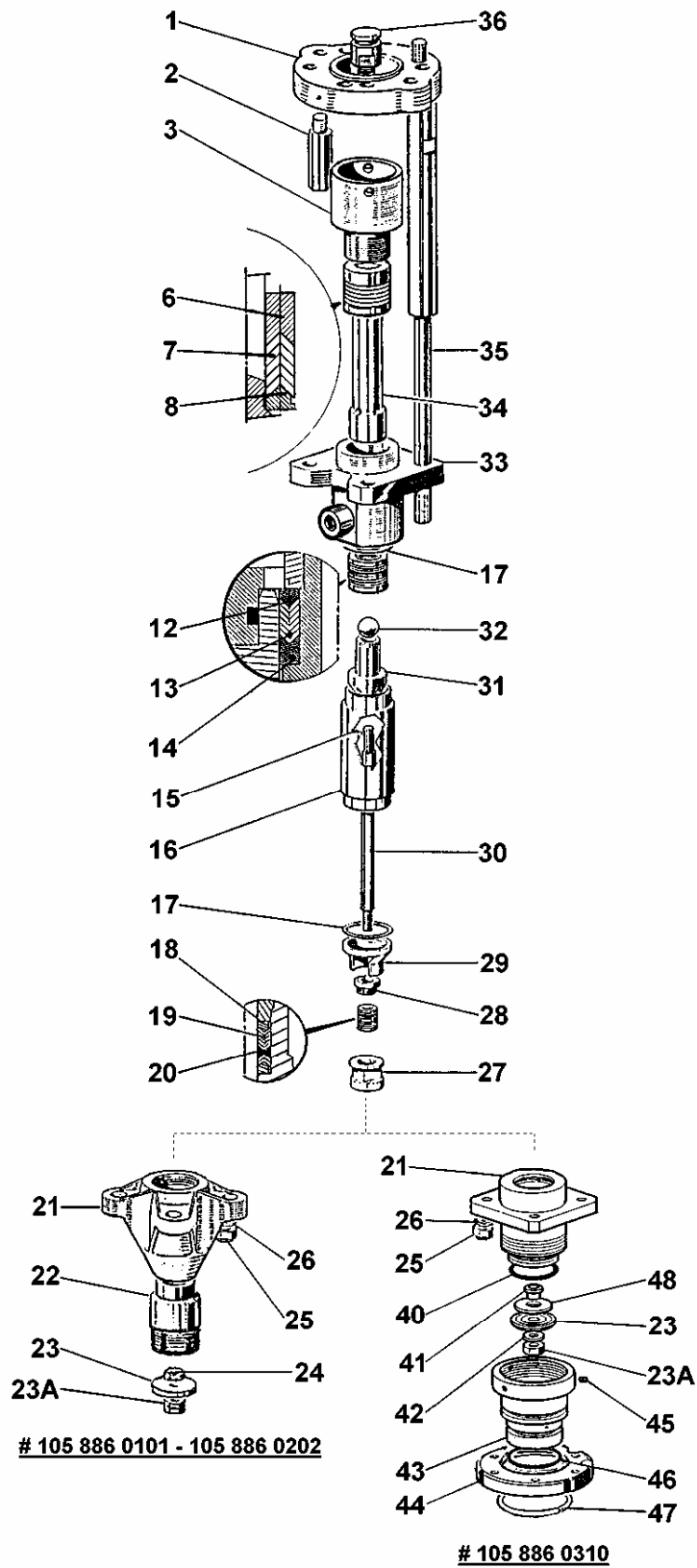

■ SPARE PARTS' LIST

Índ	Description	105 886 01 01	105 886 02 02	105 886 03 10	Qty
		#	#	#	
1	Connecting plate	207 284	207 284	207 284	1
2	Pin	209 582	209 582	209 582	2
3	Cup nut	207 278	209 987	207 278	1
6	'F' washer	40 017	209 986	40 017	1
7	Chevron seal	60 188	84 408	60 188	-
8	'M' washer	40 016	40 016	40 016	1
12	'F' washer	208 535	208 535	208 535	1
13	Chevron seal	208 534	208 534	208 534	6
14	'M' washer	208 536	208 536	208 536	1
15	Pin	88 430	88 430	84 430	1
* 16	Cylinder	207 752	207 752	207 752	1
17	FKM seal	80 037	80 037	80 037	2
18	'M' washer	60 123	60 123	60 123	2
19	Chevron seal	60 121	60 121	60 121	7
20	Spacer	60 122	60 122	60 122	1
* 21	Foot valve	60 191	60 191	207 407	1
22	Filling tube	81 67	81 67	-	1
* 23	Shovel	60 116	60 116	207 403	1
23A	Nut, model M14	91 275	91 275	91 275	1
24	Nut, model M14	88 322	88 322	-	1
25	Lock nut	88 337	88 337	88 337	4
26	Washer, model MU18	963 040 026	963 040 026	963 040 026	4
* 27	Lower valve	60 119	60 119	209 415	1
28	Cup	60 120	60 120	60 120	1
29	Valve retaining ring	60 118	60 118	60 118	1
* 30	Control rod	60 117	60 117	207 406	1
* 31	Piston bush	60 114	60 114	60 114	1
* 32	Ball	86 026	86 026	86 026	1
33	Upper body	209 414	209 414	209 414	1
* 34	Piston	60 113	60 113	60 113	1
35	Column	60 184	60 184	60 184	4
36	Coupling axis	205 915	205 915	205 915	1
* 40	FPM seal	-	-	909 130 540	1
41	Valve guide	-	-	207 405	1
42	Washer, model AZ14	-	-	88 407	1
43	Adapter	-	-	207 410	1
44	Flange	-	-	203 589	1
45	Valve	-	--	207 404	1
46	Nut, model M14	-	-	91 275	1
45	Screw, model CHc 6x6	-	-	88 265	3
* 46	FPM seal	-	-	88 040	1
47	Flange rush	-	-	203 590	1
48	Valve	-	-	207 404	1
-	Nut, model HM12	-	-	88 321	2
-	Protective housing	208 234	208 234	208 234	1
-	Screw, model CHc M4x8	88 110	88 110	88 110	1
*	Package of seals	104 019	105 890	105 034	1

* Preceding the index number denotes a suggested spare part.

Packages of seals - Composition

#	Description	Qty
104 019	Package of seals (ind. 7(x12), 12(x1), 13(x6), 17(x2), 19(x7))	1
105 890	Package of seals (ind. 6(x1), 7(x5), 12(x1), 13(x6), 17(x2), 19(x7))	1
105 034	Package of seals (ind. 7(x12), 12(x1), 13(x6), 17(x2), 19(x7))	1