



INSTRUCTION MANUAL

EXTRUSION GUN MANUAL

102 090 0101 - 102 090 0201 - 102 090 0301

Manual : 574.040.112 - 1009

Date : 13/09/2010 – Supersede : 11/09/07

Modif. : update

ORIGINAL MANUAL

IMPORTANT : Read and understand all instructions before storing, installing and operating concerned equipment (professional use only).

PICTURES AND DRAWINGS ARE NOT CONTRACTUAL. THE MATERIAL MAY BE CHANGED WITHOUT PRIOR NOTICE.

KREMLIN REXSON
150, avenue de Stalingrad
93 245 - STAINS CEDEX - FRANCE
Téléphone : 33 (0)1 49 40 25 25 - Fax : 33 (0)1 48 26 07 16
www.kremlin-rexson.com



**INSTRUCTION MANUAL
EXTRUSION GUN**

CONTENTS

| | |
|---|----------|
| 01. WARRANTY | 2 |
| 02. SAFETY INSTRUCTIONS | 2 |
| 03. EXPLODED VIEW | 6 |
| 04. PARTS' LIST | 7 |
| 05. MAINTENANCE | 8 |
| 06. REPLACEMENT OF THE NOZZLE..... | 8 |
| 07. DISASSEMBLY OF THE GUN | 8 |
| 08. GUN ASSEMBLY | 8 |

Dear Customer,

You are the owner of our new equipment and we would like to take this opportunity to thank you.

To make sure your investment will provide full satisfaction, special care has been taken by KREMLIN REXSON during all designing and manufacturing processes.

To obtain the best result, safe and efficient operation of your equipment, we advice you to read and make yourself familiar with this instruction and service manual. Indeed, the non-compliance with instructions and precautions stated in this manual could reduce the equipment working life, result in operating trouble and create unsafe conditions.

01. WARRANTY

We reserve the right to make changes; these changes may be carried out after the receipt of the order. No claim will be accepted as a consequence of any change carried out in the instruction manuals or in the selection guides.

Our equipment is checked and tested prior to shipment. In the case of a problem arising with the equipment, this must be in writing, within ten days from the delivery date.

KREMLIN REXSON warrants all equipment manufactured bearing its name, to be free from defect in material or workmanship for a period of 12 months (one shift per day or 1800 hours - 1 term reached) from the date of delivery. Work life is based on single shift working - 8 hours per day. Warranty claims for defective items will only be accepted in writing and will be verified and confirmed by us.

The warranty does not cover fair wear and tear, damage or wear caused by misuse, improper maintenance or non-observance of our recommendations.

KREMLIN REXSON will repair or replace parts (carriage paid to our plant and accepted as defective by us). We shall not be liable for any losses, resulting from a production breakdown. Upon request, we can carry out service work at your premises; all expenses (travelling and accommodation) for KREMLIN REXSON technicians will be chargeable.

In the event that it is found that equipment has been tampered with, this will invalidate the warranty. Equipment that it is bought in will be subject to the suppliers' warranty.

02. SAFETY INSTRUCTIONS

GENERAL SAFETY INSTRUCTIONS



CAUTION : The equipment can be dangerous if you do not use it according to the rules mentioned in this instruction manual. Read carefully all the instructions hereafter before operating your equipment.

Only trained operators can use the equipment. (To acquire an essential training, please contact the "KREMLIN REXSON University" training center - Stains).

The foreman must ensure that the operator has perfectly taken in the safety instructions of this equipment as well as the instructions in the manuals of the different parts and accessories.



















Read carefully all instruction manuals, label markings before operating the equipment.

Incorrect use may result in injury. This equipment is for professional use only. It must be used only for what it has been designed for. Never modify the equipment. The parts and accessories supplied must be regularly inspected. Defective or worn parts must be replaced.

Never exceed the equipment components' maximum working pressure.

Comply with regulations concerning safety, fire risks, electricity in force in the country of final destination of the material. Use only products or solvent compatible with the parts in contact with the material (refer to data sheet of the material manufacturer).

PICTOGRAMS

| | | | | | |
|---|---|---|---|---|---|
|  |  |  |  |  |  |
| NIP HAZARD | WARNING MOVING ELEVATOR | WARNING MOVING PARTS | WARNING MOVING SHOVEL | DO NOT EXCEED THIS PRESSURE | HIGH PRESSURE HAZARD |
|  |  |  |  |  |  |
| RELIEF OR DRAIN VALVE | WARNING HOSE UNDER PRESSURE | WEAR GLASSES OBLIGATORY | WEAR OF GLOVE IS OBLIGATORY | PRODUCT VAPOR HAZARDS | WARNING HOT PARTS OR AREAS |
|  |  |  |  |  |  |
| ELECTRICAL HAZARD | WARNING FIRE HAZARDS | EXPLOSION HAZARDS | GROUNDING | WARNING (USER) | WARNING SERIOUS INJURIES |

PRESSURE HAZARDS



Current legislation requires that an **air relief** shut off valve is mounted on the supply circuit of the pump motor to let air off when closing the supply circuit. Without this precaution, the motor residual air of the motor may let the pump beat and cause a serious injury.

Please ensure that, a **material drain valve** is mounted on the material circuit to drain it (after shutting down air to the motor and the pressure relief) before any servicing on the equipment. These valves must be closed for air and opened for product when processing.

HIGH PRESSURE INJECTION HAZARDS

When working with high pressure equipment, special care is required. Fluid leaks can occur. Then there are injection risks in exposed parts of body that may cause severe injuries or amputations :



- Medical care must be handled immediately if product is injected under the skin or in other parts of the body (eyes, fingers).
- Never point the spray gun at any one. Never try to stop the spray with your hands or fingers nor with rags or similars.
- **Follow the shut down procedure and always depressurize air and fluid circuits** before carrying out any servicing on the gun (cleaning, checking, maintenance of the material or cleaning of the gun nozzles).

For the guns equipped with a safety device, always lock the trigger when you do not start the gun.

FIRE - EXPLOSION - SPARKS - STATIC ELECTRICITY HAZARDS



A poor earth connection, inadequate ventilation, sparks or static electricity can cause an explosion or fire. To avoid these risks when using or servicing KREMLIN REXSON equipment, the following safety procedures must be followed :



- ensure a good earth connection and ground the parts to be handled i.e. solvents, materials, components and equipment,



- ensure adequate ventilation,

- keep working area clean and free from waste solvents, chemicals, or solid waste i.e. rags, paper and empty chemicals drums,



- never use electrical switches / power if in an atmosphere of volatile solvent vapour,

- stop working immediately in case of electrical arcs,

- never store chemicals and solvents in the working area.

TOXIC PRODUCT HAZARDS

Toxic products or vapours can cause severe injury not only through contact with the body, but also if the products are ingested or inhaled. It is imperative :



- to know the material products and their risks,

- notified or hazardous materials must be stored in accordance with the regulations,

- the material must be stored in an appropriate container, never place materials in a container where there is a risk of spillage or leakage,

- a procedure must be applied for the safe disposal of waste material. It must comply with all prevailing regulations and legislations of the country where the equipment is to be used,

- protective clothing should always be worn in compliance with the material manufacturers' recommendations,

- depending on the application and chemical safety instructions, safety glasses, gloves, foot wear, protective masks and possible breathing equipment should be worn to comply with the regulations

(Refer to chapter "Safety equipment of KREMLIN selection guide).



CAUTION!



It is forbidden using any solvent or with halogenated hydrocarbon base and also products with these solvents facing **aluminium** or **zinc**. The non-compliance with the instructions may cause explosion hazards causing serious or fatal injuries.

EQUIPMENT REQUIREMENTS

PUMP



Before carrying out any work, it is imperative to get used with the compatibilities of motors with pumps before coupling. The operator shall understand the equipment and the safety instructions. These instructions are available in the manuals of the pumps.



The air motor is designed to be mounted with a pump. Never modify any components or couplings. Where operating, please keep hands away from moving parts. Before starting up the equipment, please read the PRESSURE RELIEF instructions. Please ensure that any relief or drain valves fitted are in good working order.

HOSES

- Keep hoses out of circulation areas, moving parts or hot surfaces,
- Never expose product hoses to temperature higher than + 60°C / 870° F or lower than 0°C / 0° F,
- Never pull or use the hoses to move the equipment,
- Tighten all fittings as well as the hoses before operating the equipment,
- Check the hoses regularly; change them if they are damaged,
- Never exceed the working pressure (WP) indicated on the hose.

USED PRODUCTS

Considering the variety of products that may be used by the users and the impossibility to check off all chemical data, of possible reactions of chemicals to each other and their long term evolution, KREMLIN REXSON can not be considered as liable for :

- the bad compatibility of wetted parts,
- risks for staff and surroundings,
- for worn or out of order parts, for wrong working of equipments or units, as well as for the qualities of final product.

The user must know and prevent the possible risks as toxic vapours, fires or explosions due to used products. He shall determine the risks of immediate reactions or pursuant to repeated exposures of the staff.

KREMLIN REXSON shall not be liable for psychic injuries, direct or indirect material damages further to the use of chemicals.

03. EXPLODED VIEW

102 090 0101 : Standard version

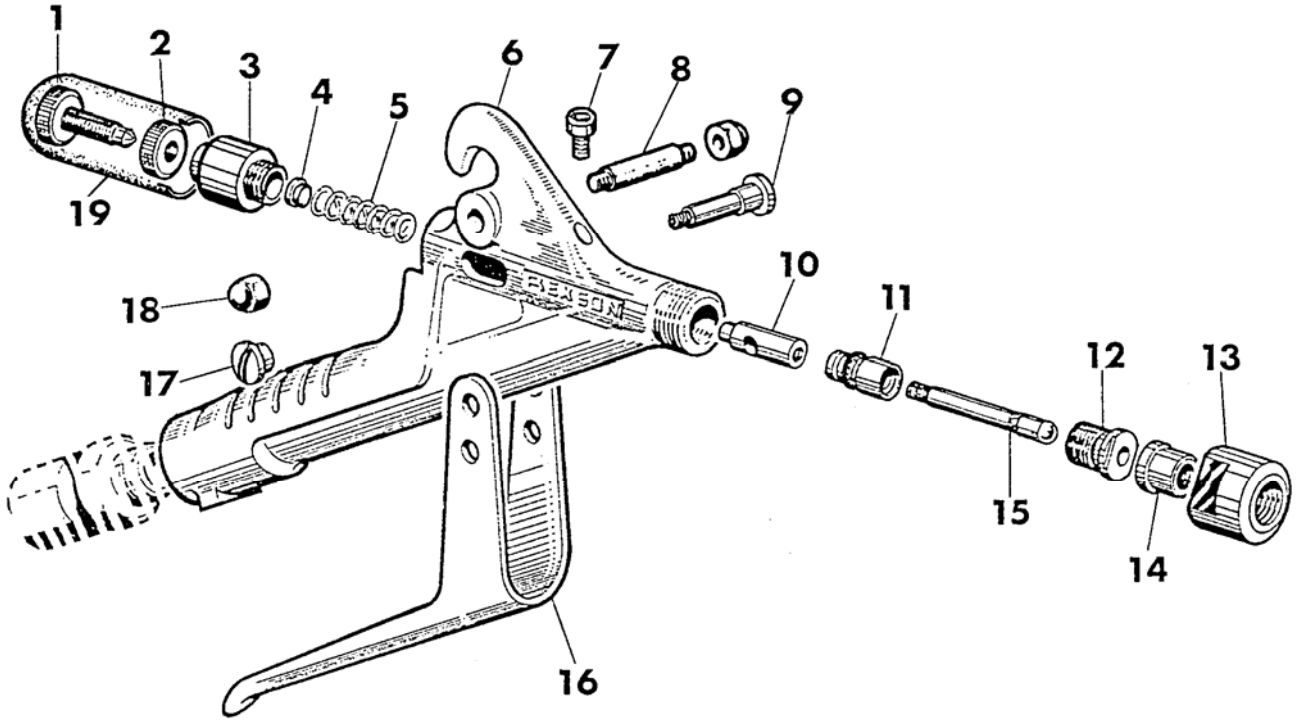

102 090 0201 and 102 090 0301 :
Versions with pneumatic sensor

Detail

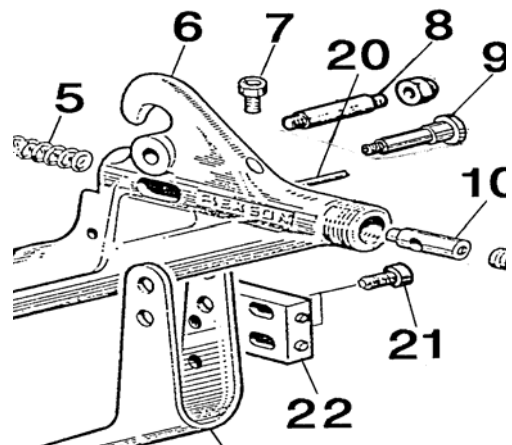

04. PARTS' LIST

| COMMON PARTS | | | | | | |
|--------------|---------|----------------------|------------------|----------------|------------------------|-----|
| Ind | # | Désignation | Description | Bezeichnung | Denominación | Qté |
| 1 | 204 673 | Vis de réglage | Adjustment Screw | Schraube | Tornillo de ajuste | 1 |
| 2 | 204 674 | Contre-écrou | Lock nut | Gegenmutter | Contra tuerca | 1 |
| 3 | 205 893 | Guide ressort | Spring guide | Federführung | Guía de muelle | 1 |
| 4 | 205 996 | Butée ressort | Spring stop | Federanschlag | Tope de muelle | 1 |
| * 5 | 205 894 | Ressort | Spring | Feder | Muelle | 1 |
| 7 | 88 111 | Vis | Screw | Schraube | Tornillo | 1 |
| 8 | 630 449 | Axe de poignée | Handle Axis | Handgriffachse | Eje de empuñadura | 1 |
| 9 | 209 990 | Axe | Axis | Achse | Eje | 1 |
| 10 | 205 891 | Guide pointeau | Needle guide | Nadelsführung | Guía de aguja | 1 |
| * 11 | 102 871 | Bague de guidage | Guide bush | Führungsring | Anillo guía | 1 |
| * 12 | 205 896 | Siège | Seat | Sitz | Asiento | 1 |
| 13 | 630 417 | Chapeau | Hat | Haube | Tapa | 1 |
| 14 | 630 421 | Embout | Threads | Muffentülle | Terminal | 1 |
| * 15 | 205 895 | Pointeau | Needle | Nadel | Aguja | 1 |
| 17 | 209 991 | Ecrou | Nut | Mutter | Tuerca | 1 |
| 18 | 88 351 | Ecrou | Nut | Mutter | Tuerca | 1 |
| 19 | 90 633 | Embout de protection | Protection piece | Schutzstück | Terminal de protección | 1 |
| * | 670 136 | Buse | Nozzle | Düse | Boquilla | 1 |

| SPECIFIC PARTS | | | | | | |
|--|-------------|---------------------|--------------------|-----------------------|--------------------|-----|
| Ind | # | Désignation | Description | Description | Denominación | Qté |
| 102 090 0101 : Standard version | | | | | | |
| 6 | NCS/NSS | Corps | Body | Körper | Cuerpo | 1 |
| 16 | 630 407 | Gâchette | Trigger | Handgriff | Gatillo | 1 |
| 102 090 0201 & 102 090 0301 : Version with pneumatic sensor | | | | | | |
| <i>102 090 0201 : sensor normally closed</i> | | | | | | |
| <i>102 090 0301 : sensor normally open</i> | | | | | | |
| 6 | NCS/NSS | Corps | Body | Körper | Cuerpo | 1 |
| 16 | 630 997 | Gâchette | Trigger | Handgriff | Gatillo | 1 |
| 20 | 88 477 | Goupille | Pin | Splint | Pasador | 1 |
| 21 | 932 151 271 | Vis | Screw | Schraube | Tornillo | 2 |
| * 22 | 630 988 | Capteur pneumatique | Pneumatic detector | Pneumatische Detektor | Captador neumático | 1 |
| - | 963 050 010 | Rondelle | Washer | Scheibe | Arandela | 2 |

* Pièces de maintenance préconisées tenues en stock

* Preceding the index number denotes a suggested spare part.

* Bezeichnete Teile sind empfohlene Ersatzteile.

* Piezas de mantenimiento preventivo a tener en stock.

N C S : Non commercialisé seul.

N S S : Denotes parts are not serviceable separately.

N S S : Bezeichnete Teile gibt es nicht einzeln, sondern nur komplett.

N C S : no suministrado por separado.

05. MAINTENANCE

Before any removal or intervention on the gun, you must isolate it by means of a safety valve (compulsory upstream of the gun) and ensure that the working pressure has been drained to avoid risks of serious injuries : spatters especially in eyes or injections under the skin can cause a blood poisoning when using such material.

The maintenance consists in checking the parts of the gun. We advice you to change the parts with an unfair wear and tear.

DON'T SOAK THE ENTIRE GUN INTO SOLVENT

06. REPLACEMENT OF THE NOZZLE

- Unscrew the nozzle from the nozzle end (14),
- Change the nozzle and screw it on the nozzle end.

07. DISASSEMBLY OF THE GUN

- Unscrew the nozzle from the nozzle end (14),
- Change the nozzle and screw it on the nozzle end,
- *Unscrew the screws (21) and put aside the pneumatic sensor (22),**
- Remove the hat (13) and put aside the nozzle end (14),
- Unlock the lock-nut (2) and unscrew the adjustment screw (1),
- Unscrew the spring guide (3), put aside the spring stop (4) as well as the spring (5),
- Unscrew the axis nut (17), take off the axis (9),
- Take off the nut (18), take off the axis (9) and recover the trigger (16),
- Unscrew the seat (12),
- Unscrew the screw (7),
- Take off the needle (15), the guide bush assembly (11) and the needle guide (10),
- Unscrew the needle and the needle guide then take off the needle from the guide bush assembly,
- Clean the parts with a solvent compatible with the material to be used,
- Check parts and change them if necessary.

* : *only for the versions with pneumatic sensor.*

08. GUN ASSEMBLY

- Carry out the gun assembly in the reverse order of the disassembly. Lubricate the movable parts and grease the seals.