

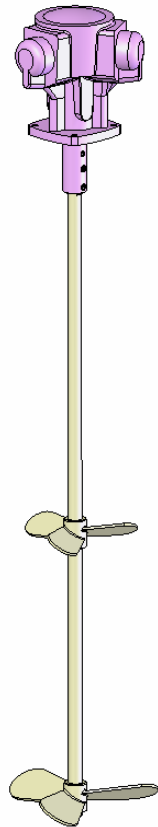

KREMLIN REXSON



INSTRUCTION MANUAL

PNEUMATIC AGITATOR
for drums from 20 to 200 L
/ from 5.3 to 52.8 US gal

CYCLIX

107 047 xxxx - 107 048 xxxx
107 059 xxxx - 107 128 xxxx

Manual : 574.024.112 - 0907

Date : 15/07/09 - Supersede : 3/11/08

Modif.: §12

IMPORTANT : Read and understand all instructions before storing, installing and operating concerned equipment (professional use only).

PICTURES AND DRAWINGS ARE NOT CONTRACTUAL. THE MATERIAL MAY BE CHANGED WITHOUT PRIOR NOTICE.

KREMLIN REXSON - 150, avenue de Stalingrad
93 245 - STAINS CEDEX - FRANCE
Téléphone : 33 (0)1 49 40 25 25 - Fax : 33 (0)1 48 26 07 16



INSTRUCTION MANUAL
PNEUMATIC AGITATOR for drums
from 20 to 200 L / from 5.3 to 52.8 US gal

CONTENTS

1.	INCORPORATION DECLARATION.....	2
2.	WARRANTY.....	3
3.	SAFETY INSTRUCTIONS	3
4.	STORING	5
5.	DESCRIPTION	5
6.	TECHNICAL FEATURES	5
7.	INSTALLATION	9
8.	ADJUSTMENTS.....	10
9.	PREVENTIVE MAINTENANCE.....	10
10.	CURATIVE MAINTENANCE	11
11.	PART NUMBERS OF THE AGITATORS.....	11
12.	SPARE PARTS' LISTS.....	12

Dear Customer,

You are the owner of our new equipment and we would like to take this opportunity to thank you.

To make sure your investment will provide full satisfaction, special care has been taken by KREMLIN REXSON during all designing and manufacturing processes.

To obtain the best result, safe and efficient operation of your equipment, we advice you to read and make yourself familiar with this instruction and service manual. Indeed, the non-compliance with instructions and precautions stated in this manual could reduce the equipment working life, result in operating trouble and create unsafe conditions.

1. INCORPORATION DECLARATION



DECLARATION D'INCORPORATION (DIRECTIVE MACHINES 98/37/CE du 22 Juin 1998)

INCORPORATION DECLARATION (MACHINE DIRECTIVE 98/37/EC from the 22nd June 1998)

DECLARACIÓN DE INCORPORACIÓN (DIRECTIVA MÁQUINA 98/37/CE del 22 de Junio de 1998)

EINGLIEDERUNGSERKLÄRUNG (DIREKTIVE 98/37/CE des 22 Juni 1998)

DICHIARAZIONE D'INCORPORAZIONE (DIRETTIVA MACCHINA 98/37/CE del 22 Giugno 1998)

Le fabricant / The manufacturer / El fabricante / Der Hersteller / Il Costruttore :

KREMLIN REXSON

150, avenue de Stalingrad

93245 - STAINS CEDEX - FRANCE

TEL : 33 (0) 1 49 40 25 25 - FAX : 33 (0) 1 48 26 07 16

...déclare que la machine ou le sous-ensemble désigné ci-dessous

/...declares that the machine or the under group mentioned hereunder

/...declara que la máquina o el sub-conjunto así como designado aquí abajo

/...deklariert da die Maschine oder die Untergruppe die unten beschrieben ist

/...dichiara che la macchina o i sottoinsieme qui' sotto descritti :

Désignation / Designation / Designación / Descrizione	PNEUMATIC AGITATOR	
Numéro de l'équipement / Equipment number / Número del equipo / Nummer der Maschine / Numero della macchina	107047xxxx	107048xxxx
	107059xxxx	107128xxxx
Marque / Trademark / Marca / Marke	KREMLIN REXSON	

	... ne pourra pas être mis en service avant que la machine dans laquelle il sera incorporé ne soit déclarée conforme aux dispositions de la directive 98/37/EC et à la législation nationale la transposant
	...could not be used before the equipment with which it will be incorporated is declared in conformity with the 98/37/CE directive clauses and international rules
	...no podría ser puesto en servicio antes que la máquina en la cual debe ser incorporado sea declarada conforme a las disposiciones de la directiva 98/37/CE y a la legislación nacional la transponando
	...nicht in gang gesetzt werden kann, solange die Maschine in die es eingebaut wird, nicht den Direktiven 98/37/CE und den nationalen Gesetzen für ihre Transponierung entsprechend anerkannt worden ist
	...non potrà essere messo in servizio prima che la macchina nella quale sarà incorporato non sarà dichiarata conforme alle disposizioni della direttiva 98/37CE delle legislazione nazionale per la sua trasposizione

Fait à STAINS, le / Established in STAINS, on / Hecho en STAINS, el / Ausgestellt in STAINS, dem / Fatto a STAINS, il:
05/10/2005

D. TRAGUS

Directeur Général / General Manager / Director General / General Direktor / Direttore Generale

2. WARRANTY

We reserve the right to make changes; these changes may be carried out after the receipt of the order. No claim will be accepted as a consequence of any change carried out in the instruction manuals or in the selection guides.

Our equipment is checked and tested prior to shipment. In the case of a problem arising with the equipment, this must be in writing, within ten days from the delivery date.

KREMLIN REXSON warrants all equipment manufactured bearing its name, to be free from defect in material or workmanship for a period of 12 months (one shift per day or 1800 hours - 1 term reached) from the date of delivery. Work life is based on single shift working - 8 hours per day. Warranty claims for defective items will only be accepted in writing and will be verified and confirmed by us.

The warranty does not cover fair wear and tear, damage or wear caused by misuse, improper maintenance or non-observance of our recommendations.

KREMLIN REXSON will repair or replace parts (carriage paid to our plant and accepted as defective by us). We shall not be liable for any losses, resulting from a production breakdown. Upon request, we can carry out service work at your premises; all expenses (travelling and accommodation) for KREMLIN REXSON technicians will be chargeable.

In the event that it is found that equipment has been tampered with, this will invalidate the warranty. Equipment that is bought in will be subject to the suppliers' warranty.

3. SAFETY INSTRUCTIONS

GENERAL SAFETY INSTRUCTIONS



CAUTION : The equipment can be dangerous if you do not use it according to the rules mentioned in this instruction manual. Read carefully all the instructions hereafter before operating your equipment.

Only trained operators can use the equipment. (To acquire an essential training, please contact the "KREMLIN REXSON University" training center - Stains).

The foreman must ensure that the operator has perfectly taken in the safety instructions of this equipment as well as the instructions in the manuals of the different parts and accessories.

Read carefully all instruction manuals, label markings before operating the equipment.

Incorrect use may result in injury. This equipment is for professional use only. It must be used only for what it has been designed for. Never modify the equipment. The parts and accessories supplied must be regularly inspected. Defective or worn parts must be replaced.

Never exceed the equipment components' maximum working pressure.

Comply with regulations concerning safety, fire risks, electricity in force in the country of final destination of the material. Use only products or solvent compatible with the parts in contact with the material (refer to data sheet of the material manufacturer).

FIRE - EXPLOSION - SPARKS - STATIC ELECTRICITY HAZARDS



A poor earth connection, inadequate ventilation, sparks or static electricity can cause an explosion or fire. To avoid these risks when using or servicing KREMLIN REXSON equipment, the following safety procedures must be followed :



- ensure a good earth connection and ground the parts to be handled i.e. solvents, materials, components and equipment,



- ensure adequate ventilation,



- keep working area clean and free from waste solvents, chemicals, or solid waste i.e. rags, paper and empty chemical drums,

- never use electrical switches / power if in an atmosphere of volatile solvent vapour,

- stop working immediately in case of electrical arcs,

- never store chemicals and solvents in the working area,

- use paint whose flash point is the highest possible to prevent from any formation of gas and inflammable vapours (refer to materials' safety instructions),

- Install a cover on the drums to reduce the diffusion of gas and vapours in the spraybooth.

TOXIC PRODUCT HAZARDS

Toxic products or vapours can cause severe injury not only through contact with the body, but also if the products are ingested or inhaled. It is imperative :



- to know the material products and their risks,

- notified or hazardous materials must be stored in accordance with the regulations,

- the material must be used in an appropriate container, never place materials in a container where there is a risk of spillage or leakage,

- a procedure must be applied for the safe disposal of waste material. It must comply with all prevailing regulations and legislations of the country where the equipment is to be used,

- protective clothing should always be worn in compliance with the material manufacturers' recommendations,

- depending on the application and chemical safety instructions, safety glasses, gloves, foot wear, protective masks and possible breathing equipment should be worn to comply with the regulations

(Refer to chapter "Safety equipment" of KREMLIN selection guide).



CAUTION!

It is forbidden using any solvent or with halogenated hydrocarbon base and also products made with these solvents facing **aluminium** and **zinc**. The non-compliance with the instructions may cause explosion hazards causing serious or fatal injuries.



USED PRODUCTS

Considering the variety of products that may be used by the users and the impossibility to check off all chemical data, of possible reactions of chemicals to each other and their long term evolution, KREMLIN REXSON can not be considered as liable for :

- the bad compatibility of wetted parts,
- risks for staff and surroundings,
- for worn or out of order parts, for wrong working of equipments or units, as well as for the qualities of final product.

The user must know and prevent the possible risks as toxic vapours, fires or explosions due to used products. He shall determine the risks of immediate reactions or pursuant to repeated exposures of the staff.

KREMLIN REXSON shall not be liable for psychic injuries, direct or indirect material damages further to the use of chemicals.

4. STORING

Place the equipment safe from dampness after having closing the different air inlets and ports (plugs).

5. DESCRIPTION

The agitators are designed to be mounted to a drum covers. They are intended for specific use to agitate liquids or semi liquids products.

The pneumatic motor of the agitator is connected to a shaft with one or 2 blades. It enables to produce an homogeneous mix.

6. TECHNICAL FEATURES

■ DIMENSIONS

	#	A "	B "	C "	X prope ller Ø "	Y prope ller Ø "	Weight lb	Power		Torque ft/lbs	Max air consum ption (l/mn)
								(CV)	(kW)		
M 1	107059 01 01	4.7	15.9	20.7	5.9	-	7.7	1/8	0.10	0.5	204
	107059 07 03		32.7	37.4	7.9	5.9	9.2				
M 3	107047 01 01	5.9	15.9	21.9	5.9	-	9.7	1/4	0.20	1.01	261
	107047 07 03		32.7	38.6	7.9	5.9	11.2				
	107047 07 05		32.7	38.6	14.5	14.5	11.2				
M 5	107048 01 01	7	16.3	23.4	5.9	-	11.2	1/2	0.37	2.2	400
	107048 07 03		33	40.2	7.9	5.9	12.8				
	107048 07 05		33	40.2	14.5	14.5	13.4				
M 3R	107128 01 04	10.7	16.3	27	7.9	-	19.8	1/2	0,37	11.7	261
	107128 07 04		33	43.7	7.9	7.9					
	107128 07 05		33	43.7	14.5	14.5					

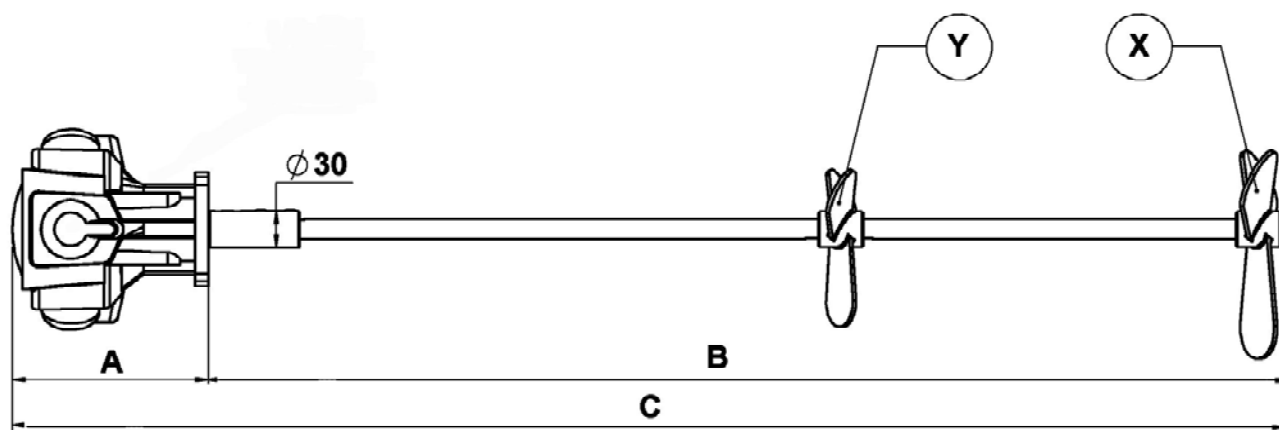

■ LAYOUT

Layout of the M1, M3, M5 motors on cover

M1 & M3 Motors

↻ 4 Ø 7 holes located on a 91 mm / 3.6" diameter.

M5 Motors

↻ 4 Ø 9 holes located on a 114 mm / 4.5" diameter.

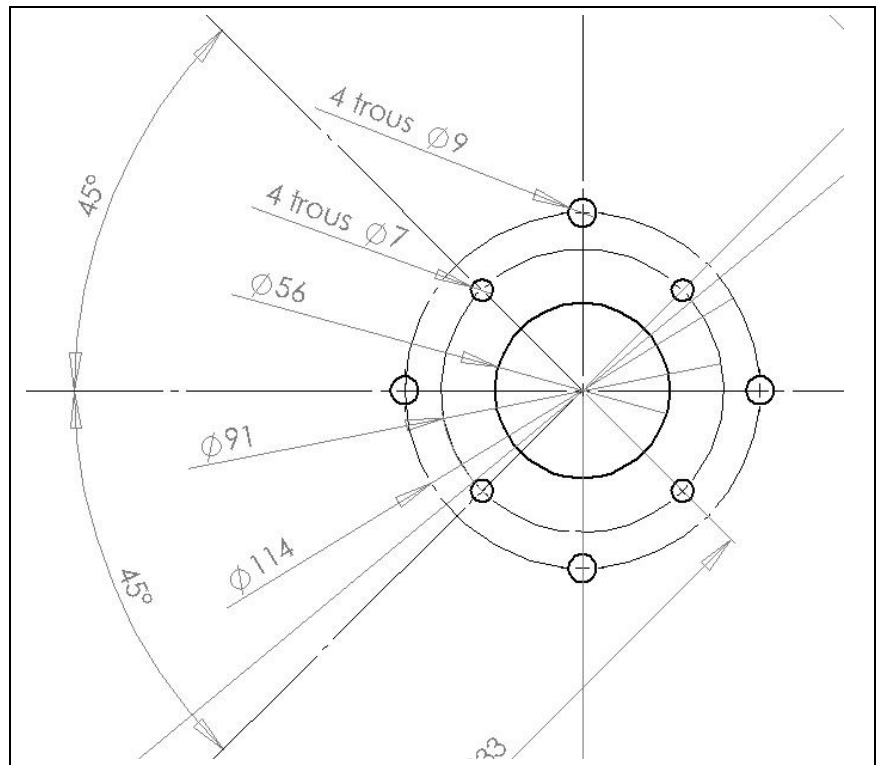





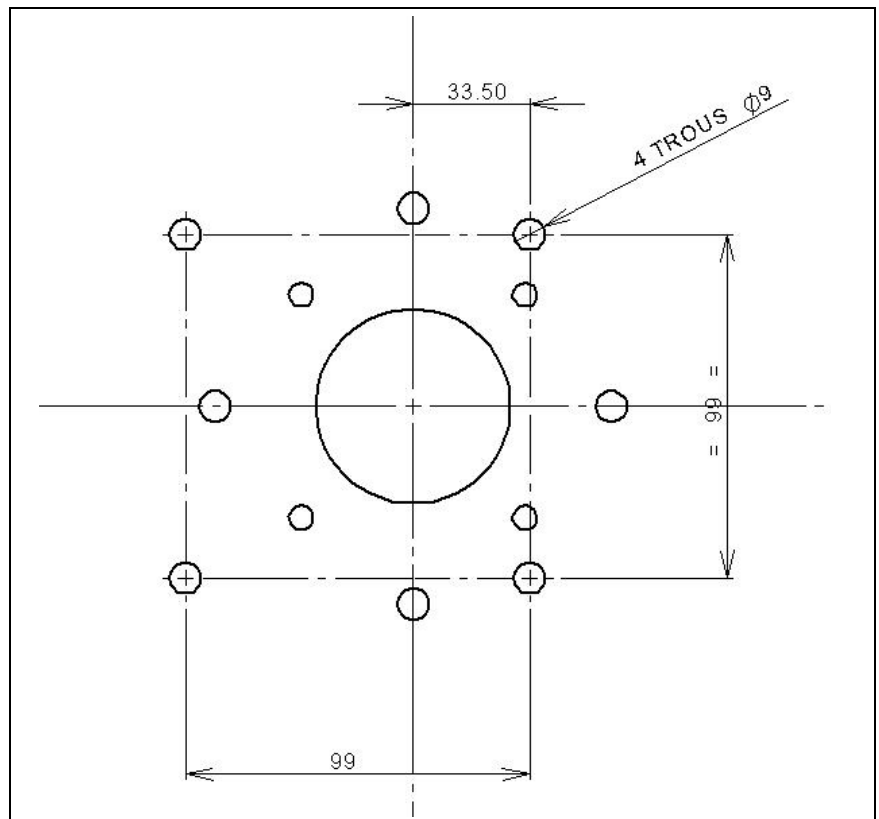

Layout of the M3 R motor on cover

M3R Motor

↻ 4 Ø 9 holes located on a 99 mm / 3.9" side square.

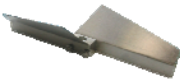

■ SELECTION OF THE AGITATOR

Viscosity (AFNOR cup N° 4)	Very low < 18 s	Low Between 18 and 25 s	Medium Between 25 and 100 s	High > 100s
Motor model	M 1	M 3	M 5	M 3R
Propeller model (according to version)		 or 	 or 	 or 

■ FEATURES OF THE AGITATOR MOTORS

CURVES OF PERFORMANCES

The following curves indicate the ratio of "torques / powers / rotation speed and air consumption" for a regular air supply pressure.

ROTATION

We advise you not to exceed the maximum speed indicated to ensure a larger motor life time.
A speed lower than the minimum indicated will not be stabilized.

TORQUE AND ROTATING SPEED

The number of turns decreases when the torque is used (torque and rotation are inversely proportional).

POWER

You will get a maximum power of the motor using the motors to an intermediate speed (between minimum and maximum), It enables to economize on the energy.

AIR CONSUMPTION

It is proportional to the stress asked to the motor.

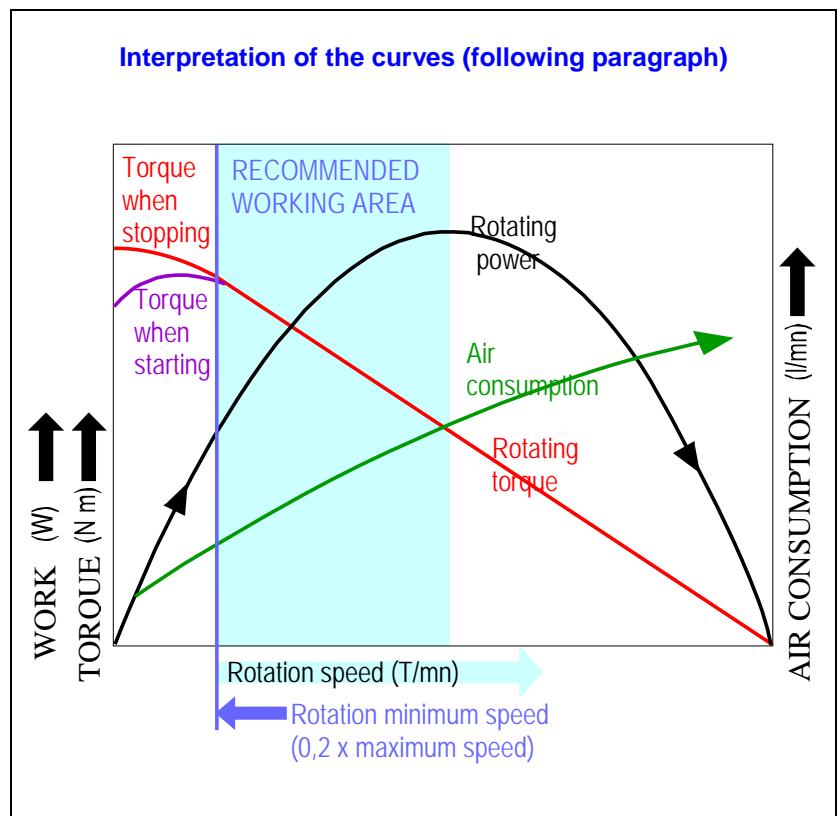

For your information : 1MPa = 10 bar / 145 psi

■ AIR CONSUMPTION OF THE AGITATORS' MOTORS

Agitator # : 107059 xx xx (motor, model M1)

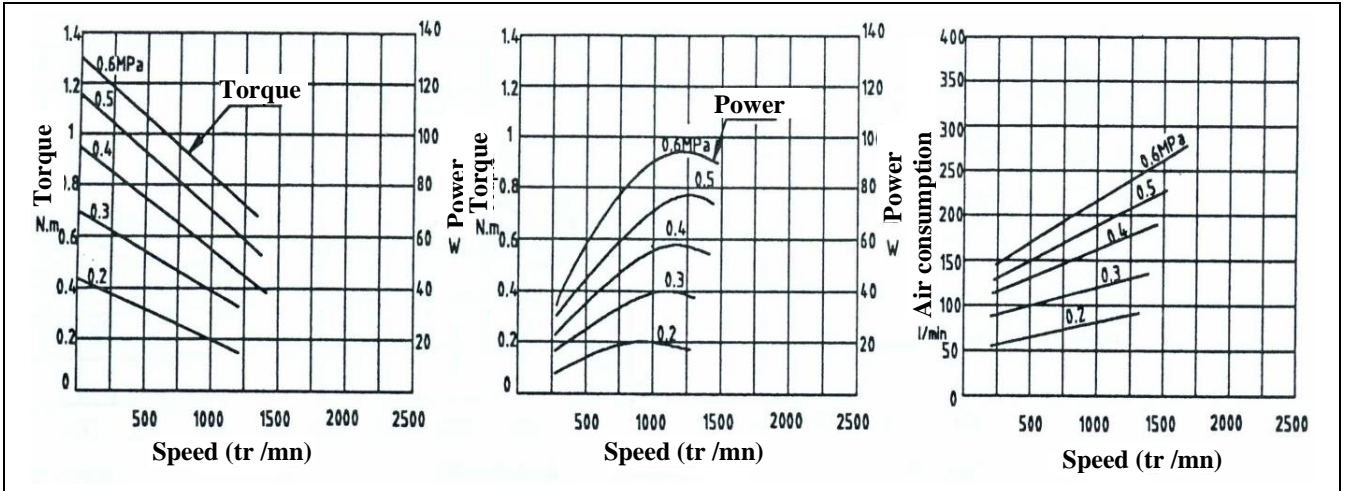

Agitator # : 107047 xx xx (motor, model M3)

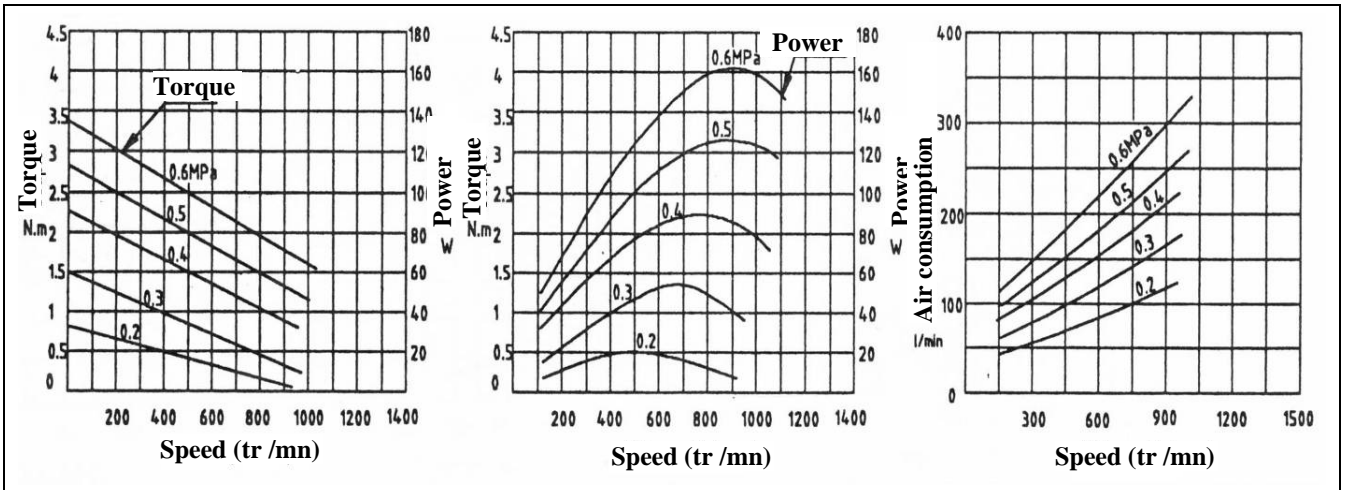

Agitator # : 107048 xx xx (motor, model M5)

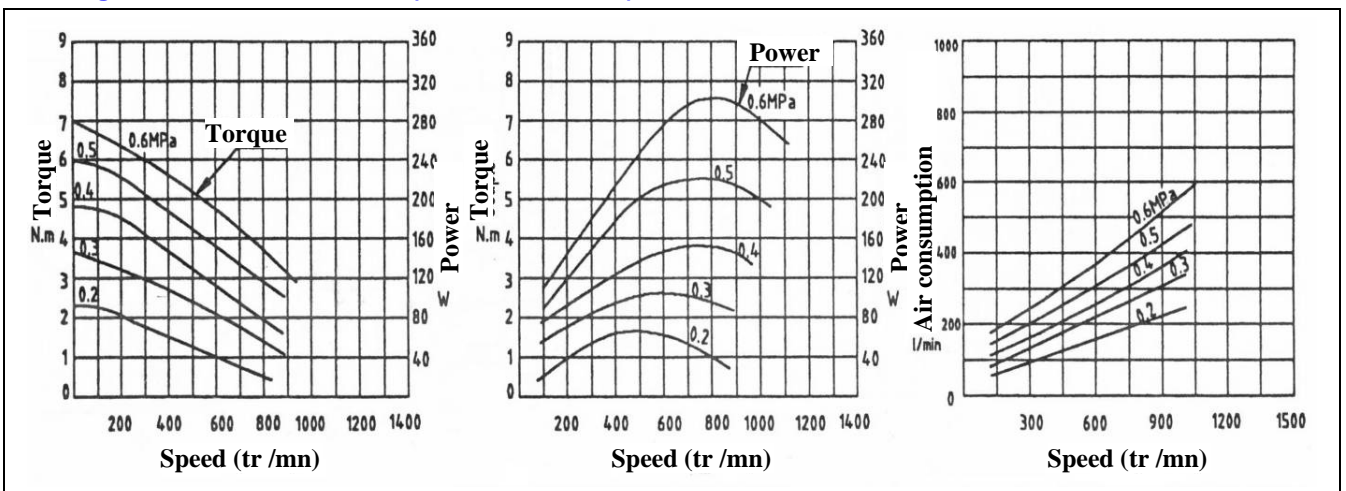

For the agitator 107128 XX XX, refer to the agitator 107047 (the maximum torque with the reducer is of 11,8 N/m / 8.7 ft/lbs).

7. INSTALLATION

■ ASSEMBLY

Remove the propellers of the agitator (A)

Place the motor of the agitator in the centre of the cover (B) and fix it by means of the screws, washers and nuts.

Place the suction rod (C).

Assemble the return rod (D).

Mount the upper propeller.

Assemble the flange with its ring between the agitator rod and the return rod.

Mount the lower propeller.

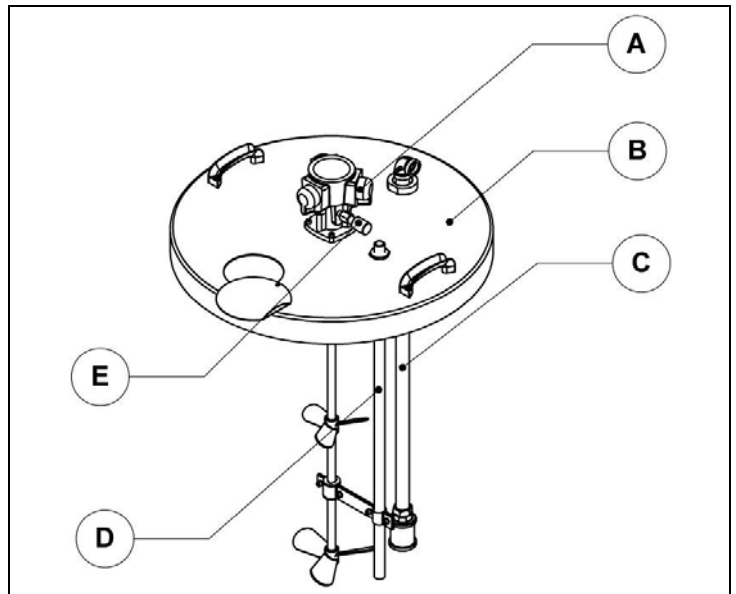

■ GROUNDING



Ground the earth cable of the cover to a safe earth. The agitator is grounded via the cover.

➞ Refer to instruction manual of the mixing units.

■ CONNECTION OF THE COMPRESSED AIR SUPPLY



To ensure a correct operating and an optimum working life of the agitator, the compressed air must be clean (without water), supply air must be filtered and lubricated.

➞ **Install an FRL on the agitator air supply.**

Nota - For the units on elevator :

Air supplies the agitator via a hose fitted with a quick release fitting that can be connected to the elevator according to the working stage.

➞ When you have to rise or fall the cover, the air hose must be connected to the elevator; there is no air on the motor of the agitator.

➞ When the air hose is connected on the motor of the agitator, that one is on the move; you cannot rise or fall the cover.

■ SPECIFIC INSTRUCTIONS



Before operating the equipment, please ensure that the operators have been trained to use the equipment correctly.

The foreman must ensure that the operators have perfectly taken in the safety instructions of this equipment as well as the instructions in the manuals of the different parts and accessories.



The operator must wear the appropriate clothing (protective masks, gloves, glasses...) depending on the use of the equipment.

Do not supply the equipment with liquids or gas, other than compressed air.

Keep away from moving parts. Do not stay in front of the exhaust.

Do not supply the equipment with air pressures up to the ones recommended. Damages can occur if you use the equipment with speeds up to the ones recommended.

Nota : You must lubricate the motor of the agitator. Dirts due to oil can be present on the cover. To avoid them, mount a grease recovery assembly to the motor exhaust (see option).

8. ADJUSTMENTS

Before operating the equipment, check that the agitator is correctly grounded on the cover and that ground is carried out.



A lubrication of the equipment is necessary.
Supply air must be filtered and lubricated.
The maximum air supply pressure is 6 bar / 87 psi.

Adjustment of the lubricator

Motor version	Nb of drops / mn
M1	1-2
M3 -M3R	1-2
M5	2-3

Unscrew slightly the knob of the agitator air flow regulator to make the motor operate very slowly for a while, then make it work normally.

NOTA : Do not operate the agitator to a too important speed. It can lead to a deterioration of the paint, vibrations and an early wear of the parts. The agitator is for the homogenization of the paint.



Keep away hands and fingers from the blades of the agitator. Serious injuries can occur.

9. PREVENTIVE MAINTENANCE



To prevent from injuries, material injections, injuries due to moving parts or sparks during the stopping of the system, the assembly, the cleaning or changing of a component, **you must shut off the air inlet** of the agitator before intervening

Motor of the agitator :

To prevent from an early wear of the agitator, check regularly the filter and the lubricator mounted upstream the agitator.

Carry out a periodic maintenance for the internal lubrication of the agitator (refer to drawing - HP 150 oil).

Blades of the agitator

The blades must be cleaned regularly.

Check the cleanliness of the muffler regularly.

Clean and change it if it is clogged up.

**INTERNAL LUBRICATION
OF THE AGITATOR
(REMOVE THE SCREWS OF
THE UPPER COVER)**



10. CURATIVE MAINTENANCE



Before any intervention on the equipment, shut off the air supply of the agitator and follow the general safety instructions.

FAULTS	CAUSES	SOLUTIONS
The agitator does not start up or its speed is too low	Insufficient air supply of the agitator	Raise the air pressure unscrewing the needle valve of the air regulator. Check the air supply pressure upstream of the agitator.
	Restrictive exhaust Insufficient lubrication	Clean the muffler and change it if necessary. After having disconnected the motor from the network, inject some oil drops directly on the motor (via the quick release fitting).
Over heat	Insufficient lubrication	Add oil drops via the quick release fitting or the internal lubrication of the motor.
	Too important rotative speed	Reduce the agitator rotative speed.

If the motor of the agitator has a blockage, then please contact KREMLIN REXSON or the appropriate distributor.

11. PART NUMBERS OF THE AGITATORS

Motor version	# Agitators for drums from 20 to 40L / from 5.3 to 10.6 US gal	# Agitators for 200L / 52.8 US gal drum	
		2 "navy" propellers "	2 "sabre" propellers
	1 "navy" propeller version 01	2 "navy" propellers "	2 "sabre" propellers
M1	107 059 01 01	107 059 07 03	-
M3	107 047 01 01	107 047 07 03	107 047 07 05
M5	107 048 01 01	107 048 07 03	107 048 07 05
	1 propeller with perforated blades	2 propellers with perforated blades	2 "sabre" propellers
M3R	107 128 01 04	107 128 07 04	107 128 07 05

12. SPARE PARTS' LISTS

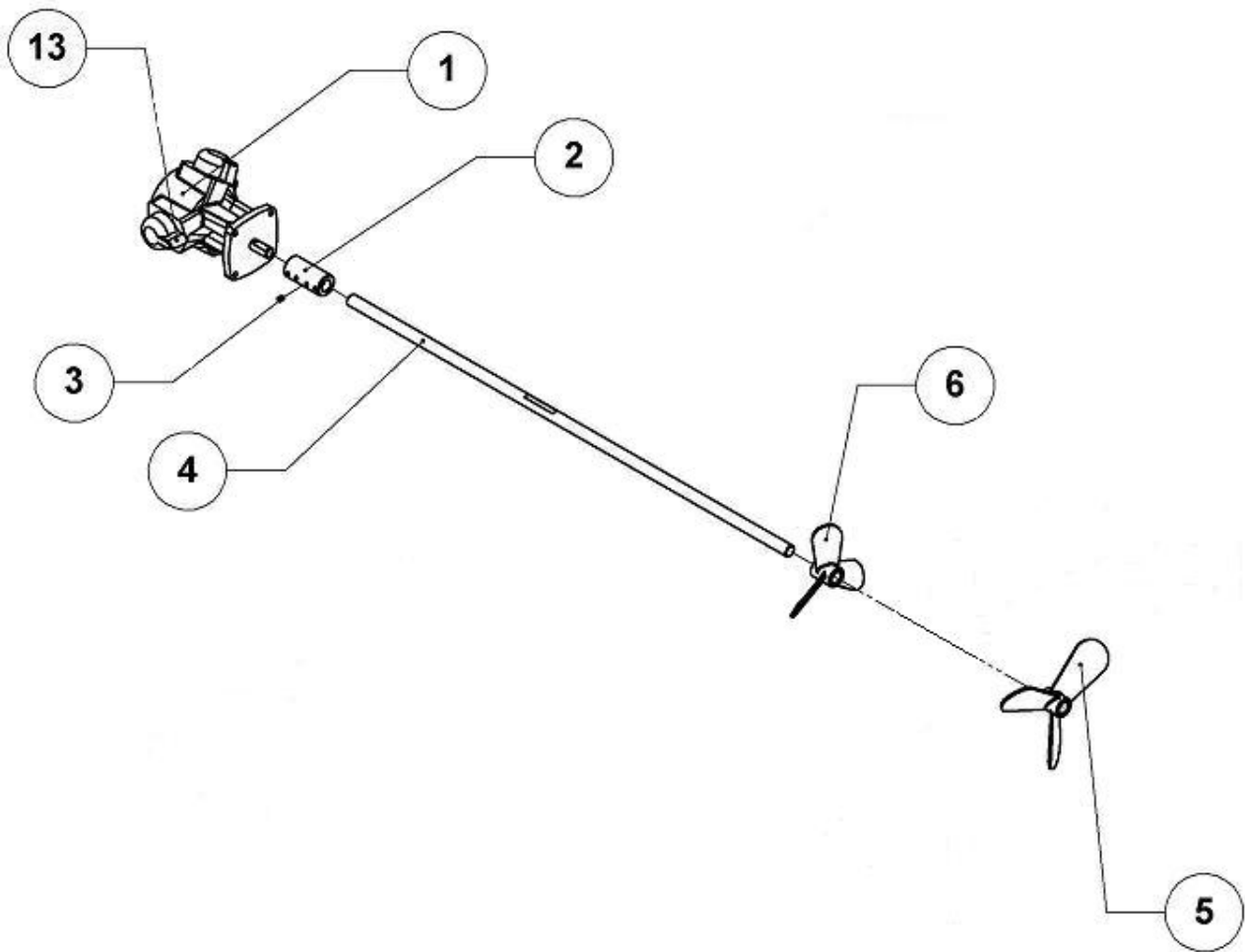

AGITATOR : # 107 059 xx xx

Ind.	Description	Qty	Material	1070590101	1070590703
1	Agitator motor, model M1	1	-	91304	91304
2	Motor coupling	1	Steel	91562	91562
4	Agitator rod	1	Steel	211360	91874
5	Propeller, model X	1	Steel	91876	91875
6	Propeller, model Y	1	Steel	-	91876
13	Air flow regulator	1	-	91930	91930
-	Package of screws (fixing)	1	Steel	054.260.513	054.260.513
	Flange (for motor, model M1)	1	Alu	054.260.193	054.260.193
	Screw, model CHc M6x16	4	Steel	88512	88512

AGITATOR : # 107 047 xx xx

Ind.	Description	Qty	Material	1070470101	1070470703	1070470705
1	Agitator motor, model M3	1	-	91880	91880	91880
2	Motor coupling	1	Steel	91877	91877	91877
4	Agitator rod	1	Steel	211360	91874	91874
5	Propeller, model X	1	Steel	91876	91875	90926
6	Propeller, model Y	1	Steel	-	91876	90926
13	Air flow regulator	1	-	91930	91930	91930
-	Package of screws (fixing)	1	Steel	054.260.513	054.260.513	054.260.513

AGITATOR : # 107 048 xx xx

Ind.	Description	Qty	Material	1070480101	1070480703	1070480705
1	Agitator motor, model M5	1	-	91881	91881	91881
2	Motor coupling	1	Steel	91878	91878	91878
4	Agitator rod	1	Steel	211360	91874	91874
5	Propeller, model X	1	Steel	91876	91875	90926
6	Propeller, model Y	1	Steel	-	91876	90926
13	Air flow regulator	1	-	91930	91930	91930
-	Package of screws (fixing)	1	Steel	054.260.514	054.260.514	054.260.514

AGITATOR : # 107 128 xx xx

Ind.	Description	Qty	Material	1071280104	1071280704	1071280705
1	Agitator motor, model M3R	1	-	91925	91925	91925
2	Coupling motor	1	Steel	91775	91775	91775
4	Agitator rod	1	Steel	211360	91874	91874
5	Propeller, model X	1	Alu	30751	30751	90926
6	Propeller, model Y	1	Alu	-	30751	90926
13	Air flow regulator	1	-	91930	91930	91930
-	Package of screws (fixing)	1	Steel	054.260.514	054.260.514	054.260.514

PNEUMATIC MOTOR

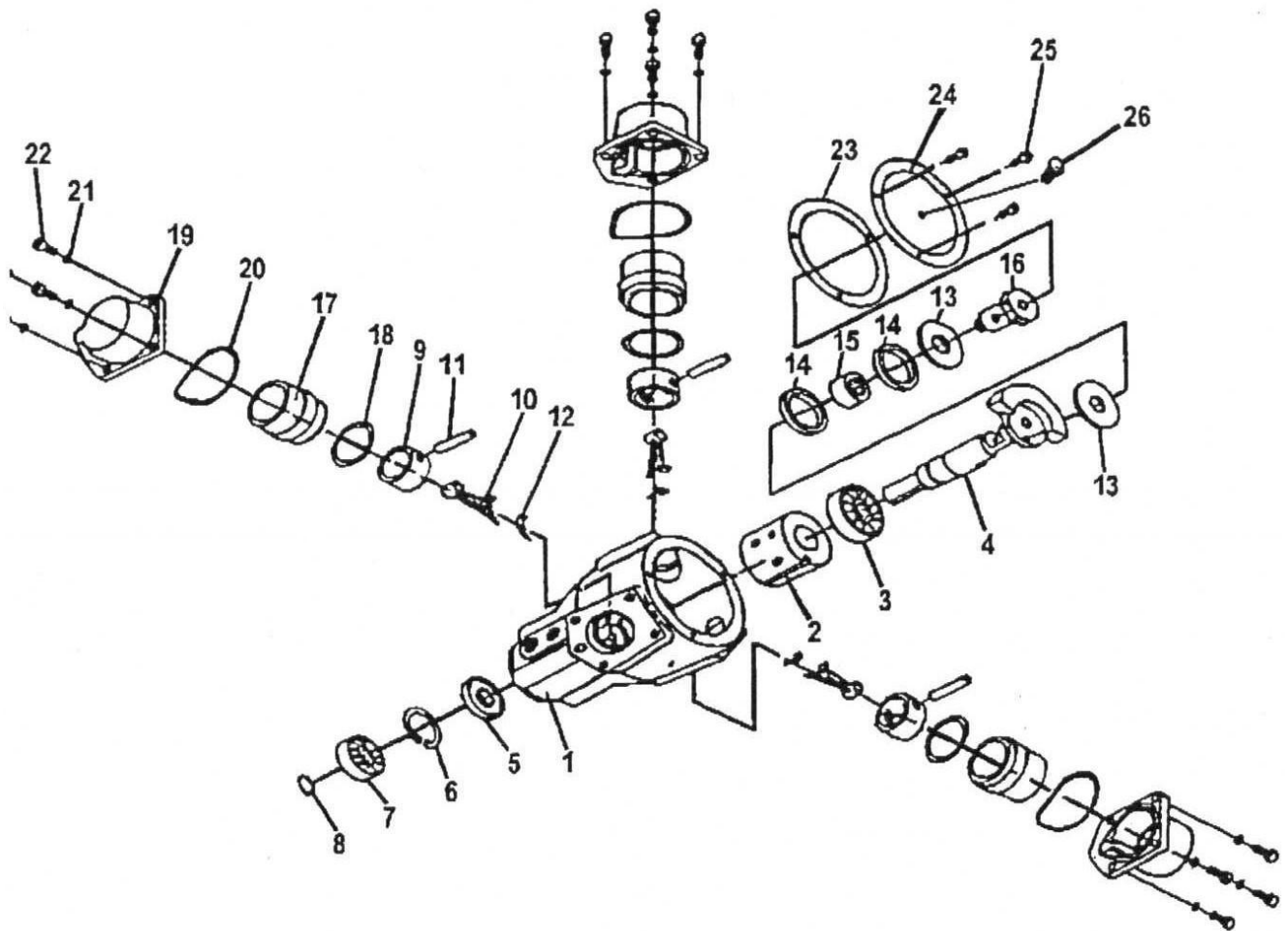

#	M1	M3	M5	M3R
Motor	91304	91880	91881	91925
Servicing kit	92081	92082	92083	92082







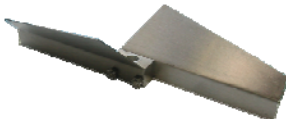

Servicing kit composition

Index	Description	Quantity for motor, model M1	Quantity for motor, models M3 and M3R	Quantity for motor, model M5
5	Seal (oil)	1	1	1
9	Piston	3	3	5
10	Connecting rod	3	3	5
11	Pin	3	3	5
12	Seal	3	3	5
14	Ring	2	2	2
15	Needle gear	1	1	1
17	Piston sleeve	3	3	5
18	O-Ring	3	3	5
20	O-Ring	3	3	5

ACCESSORIES

Propeller version	MARINE (3 stainless steel blades)	SABRE (stainless steel full blade)	With blades (perforated blades - aluminium)
Use	Fluid viscosity < 300 cp	Fluid viscosity > 300 cp	Fluid viscosity > 2000 cp
			
Part number	91875 (Ø 200 / 7.9" - 0,265 kg / 0.6 lb) 91876 (Ø 160 / 6.3" - 0.2 kg / 0.44 lb)	90926 (Ø 370 / 14.5" - 0.6 kg / 1.32 lb)	30751 (Ø 200 / 7.9" - 0.175 kg / 0.39 lb)

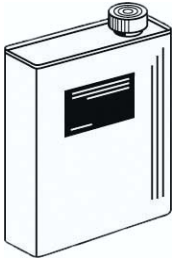
Air lubricator	Air filter	Lubricator bracket	Filter bracket
			
1/4 " → # 91554 3/4 " → # 91535	1/4 " → # 91553 3/4 " → # 91534	1/4 " → # 91548 3/4 " → # 91546	# 91547

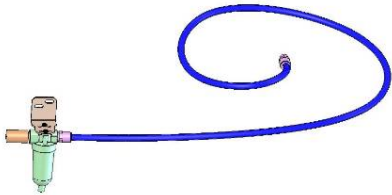
Lubricant can for motor - 2 Liters (HP 150 oil)	Air supply kit for assembly on elevator (hose length : 650 mm / 25.6")	Escape assembly with oil container (hose length : 1 m / 39.4")
		
# 149.990.017	M 1/2" or F 1/4" → # 91863	# 107159