



INSTRUCTION MANUAL
PROPORTIONING SYSTEM - MODEL PU 2200

Manual : 0808 573.070.110

Date : 13/08/08 - Annule/Supersede : 1/10/04

Modif. : Doc. 573.128.050

KREMLIN REXSON – 150, avenue de Stalingrad
93 245 - STAINS CEDEX - FRANCE
Téléphone : 33 (0)1 49 40 25 25 Fax : 33 (0)1 48 26 07 16



INSTRUCTION MANUAL
PROPORTIONING SYSTEM - MODEL PU 2200

SUMMARY

1.	EC DECLARATION OF CONFORMITY	2
2.	SAFETY INSTRUCTIONS	2
3.	TECHNICAL FEATURES	4
4.	OPERATING PRINCIPLE.....	6
5.	INSTALLATION	7
6.	START UP.....	11
7.	FLUSHING	13
8.	SHUTDOWN AT END OF WORK	14
9.	SERVICING.....	14
10.	CHECKING AND TROUBLESHOOTING	15
11.	INSTALLATION OF A FLUID SECTION - MODEL FLOWMAX®.....	17
12.	LEVER-ARM ADJUSTMENT - MIX RATIO - PRESSURE RATIO	18

PARTS IDENTIFICATION LIST	# Doc.	PARTS IDENTIFICATION LIST	# Doc.
PU 2200 proportioning system	573.125.050		
Air motors, models :		Manifold	573.126.050
250-4	573.047.050	Mixer	573.127.050
500-4	573.031.050	Lever-arm	573.129.050
1000-4	573.045.050	Air supply	573.128.050
2000-4	573.046.050		
Reversing block	573.087.041	Flushing pumps :	
Fluid sections :		10.14 pump	573.130.050
25 (GT)	573.032.050	- 340/2 air motor	573.023.050
50 (GT)	573.080.050	- 14 cc fluid section	573.672.040
120	573.049.050		
Fluid sections (FLOWMAX®)		20.25 pump	573.131.050
PU 12,5 F	573.184.050	- 500/4 air motor	573.031.050
PU 25 F	573.134.050	- 25 cc fluid section	573.032.050
PU 50 F	573.133.050		
PU 120 F	573.132.050		

Dear customer,

We thank you very much for purchasing our PU 2200 two-component pump. You are the owner of one of the most reliable pumping systems available on the market.

Special care has been taken during all designing and manufacturing processes to make sure your investment will provide full satisfaction.

To get the best result, safe and efficient operation of your equipment, we advise you to read and make yourself familiar with this instruction and service manual. Indeed, the non-compliance with instructions and precautions stated in this manual could reduce the equipment working life, result in operating trouble and create unsafe conditions.

1. EC DECLARATION OF CONFORMITY

The manufacturer : **KREMLIN REXSON** with assets of 6 720 000 euros

Head office : 150, avenue de Stalingrad – 93 245 - STAINS CEDEX - FRANCE

Tel. 33 (0)1 49 40 25 25 - Fax : 33 (0)1 48 26 07 16

Herewith declares that : Pneumatic pump, is in conformity with the provisions of :

EC - Machinery Directive (Directive 98/37/EC) as amended and with national implementing legislation

Ex - ATEX Directive (Directive 94/9/EC) :  II 2 G (group II, class 2, gas).

Established in Stains, on March 1st 2003,

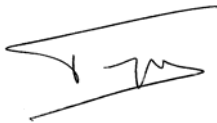

Daniel TRAGUS
President

2. SAFETY INSTRUCTIONS



WARNING : Any misuse of the equipment or accessories can damage them, result in serious body injury, fire or explosion hazard and reduce the equipment working life. Read, understand and comply with the safety instructions hereafter.

The personnel involved in operating and servicing this equipment must be aware of all safety requirements stated in this manual. The workshop supervisor must be certain that the personnel has perfectly understood the safety instructions and complies with them.

Read all instruction manuals as well as the tags of the equipments before operating the equipment.

Refer to local safety instructions and comply with them.

■ INSTALLATION REQUIREMENTS

➔ Ground the equipments.

Use the equipment only in a well-ventilated area to prevent from serious body injuries, fire and explosion hazards. Do not smoke in the spray area.

Never stock paints and solvents in the spray area. Always close the pots and the tins.

Always keep the spray area clean and free from debris (solvent, rags,...).

Read paint and solvent manufacturer's technical instructions.

Spraying of some materials may result in hazardous working conditions. To protect the operator, respirator mask, hand cream and glasses are required. (Refer to chapter "Safety equipment" of KREMLIN selection guide).

■ EQUIPMENT REQUIREMENTS

The operating pressure of these equipments are particularly high. Consequently, some precautions must be taken in order to prevent from accidents and from unsafe working conditions.

- ➔ **Never exceed the components maximum working pressure of the equipment.**

HOSES

Do not use hoses with a maximum burst-proof pressure less than four times the maximum service pressure of the pump (see data sheet).

Be certain the hoses are not crimped, leaking and not unrolled.

Be certain hoses are in good conditions and showing no evidence of damage.

- ➔ **Use only air hose with static conductor to connect the pump with the spray gun.**

All fittings must be tight and in good condition.

PUMP

- ➔ **Ground the equipment (use the connection on the pump).**

The compressed air supply must not exceed 6 bar / 87 psi.

Use the appropriate solvent for the material being sprayed to increase the equipment working life.

Do not use any product or solvent incompatible with the pump components (halogen hydrocarbon-based solvent must not be used in the pump) – (see data sheet). For specific cases : contact your authorized supplier to get appropriate solvents for the preparation of the materials or cleaning of the pump.

GUN

Never wipe the end of the tip with the fingers.

Always depressurize air and hoses before carrying out any servicing on the gun.

Never point the spray gun at anyone or at any part of the body.

■ MAINTENANCE REQUIREMENTS

- ➔ **Never modify these equipments.**

Check them daily, keep them in a good condition and replace the worn parts **only with KREMLIN parts**.

Before cleaning or removing components of the equipment, it is compulsory :

- 1 - to stop the pump by shutting off the compressed air supply,**
- 2 - to open the pump drain valve,**
- 3 - to point the gun into an appropriate waste receptacle and press the gun trigger to depressurize the system.**

3. TECHNICAL FEATURES

The PU 2200 variable ratio pump is used for applying two-component material with conventional, AIRMIX[®], and electrostatic spray guns (depending on the model chosen).

The PU 2200 pump is mounted on a chassis with a protective cover. Incorporating the basic equipments it is also designed to receive the optional accessories.

Air motor : 250-4, 500-4, 1000-4, 2000-4 - **depending on the model chosen.**

BASE fluid section : Standard : 25, 50, 120 } **depending**
FLOWMAX[®] : 25, 50, 120 } **on the model**

CATA fluid section: Standard : 25, 50, 120 } **depending**
FLOWMAX[®] : 12.5, 25, 50, 120 } **on the model**

Lever arm : Proportioning adjustment : 1 to 3 times.

Mix ratio : depending on the fluid section model (see chapter 12).

Pressure ratio : depending on fluid sections and air motor models (see chapter 12).

Material viscosity : 180 s CA4 maxi.

Air supply pressure : minimum : 2 bar - maximum : 6 bar.

Operating temperature : maximum : 60° C

Sound level: < 82 dbA

Flushing pump : 10.14 or 20.25

Metals in contact with the material :

Pump cylinder : Stainless steel.
Manifold : Check valve : aluminium + stainless steel - Valve : steel
Mixer : Corrosion resistant steel.

Connections and dimensions :

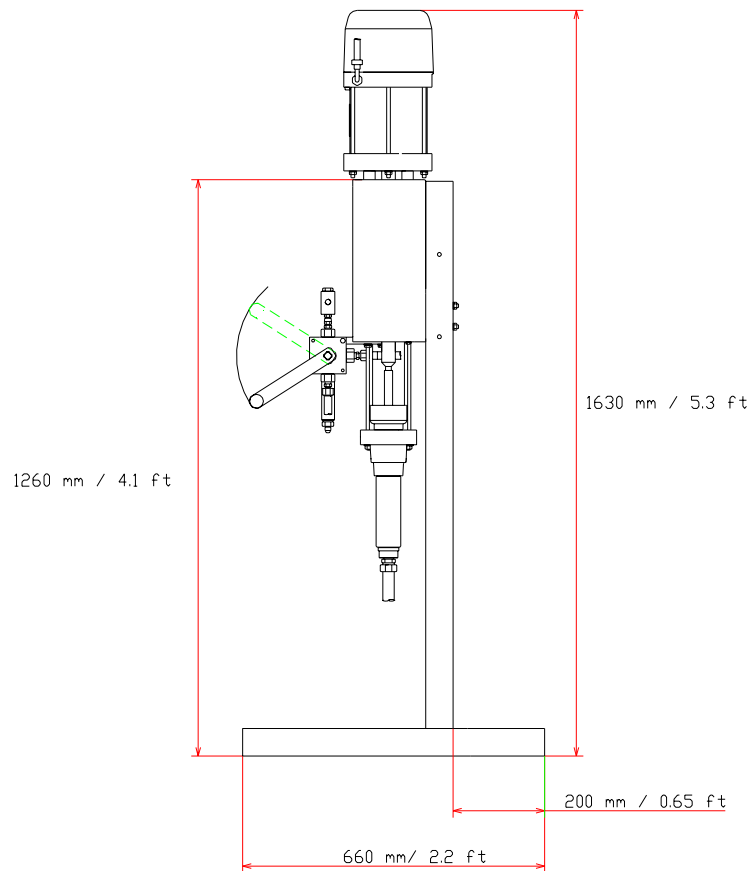
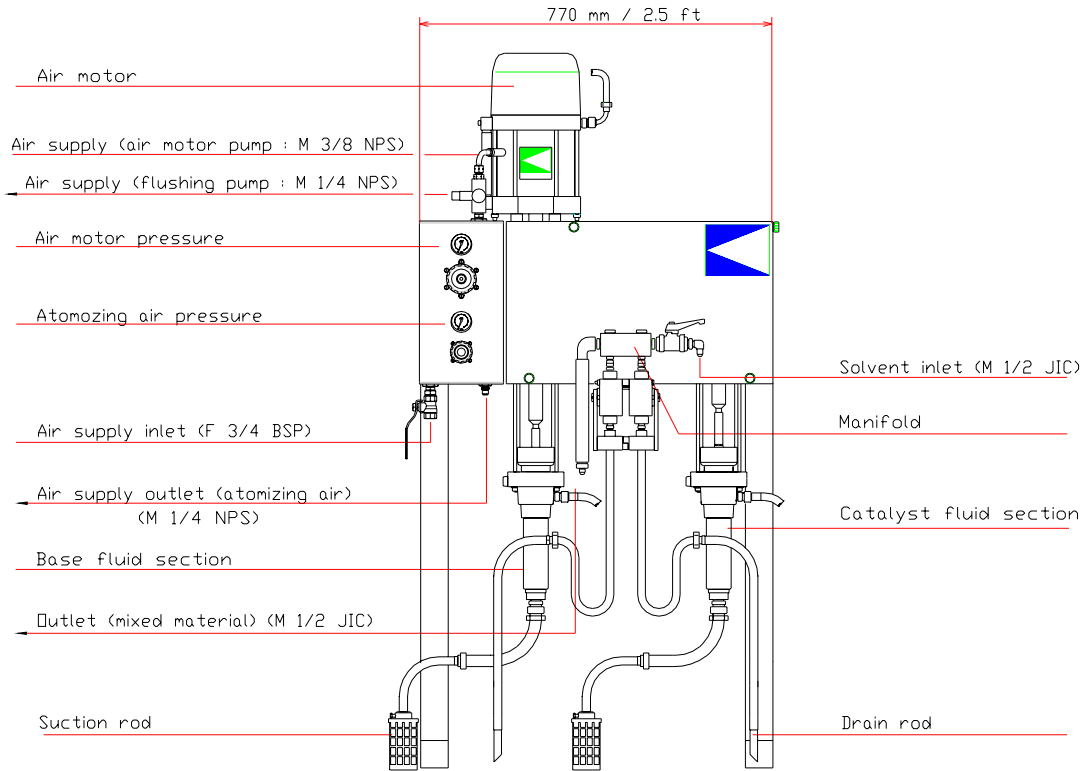

4. OPERATING PRINCIPLE

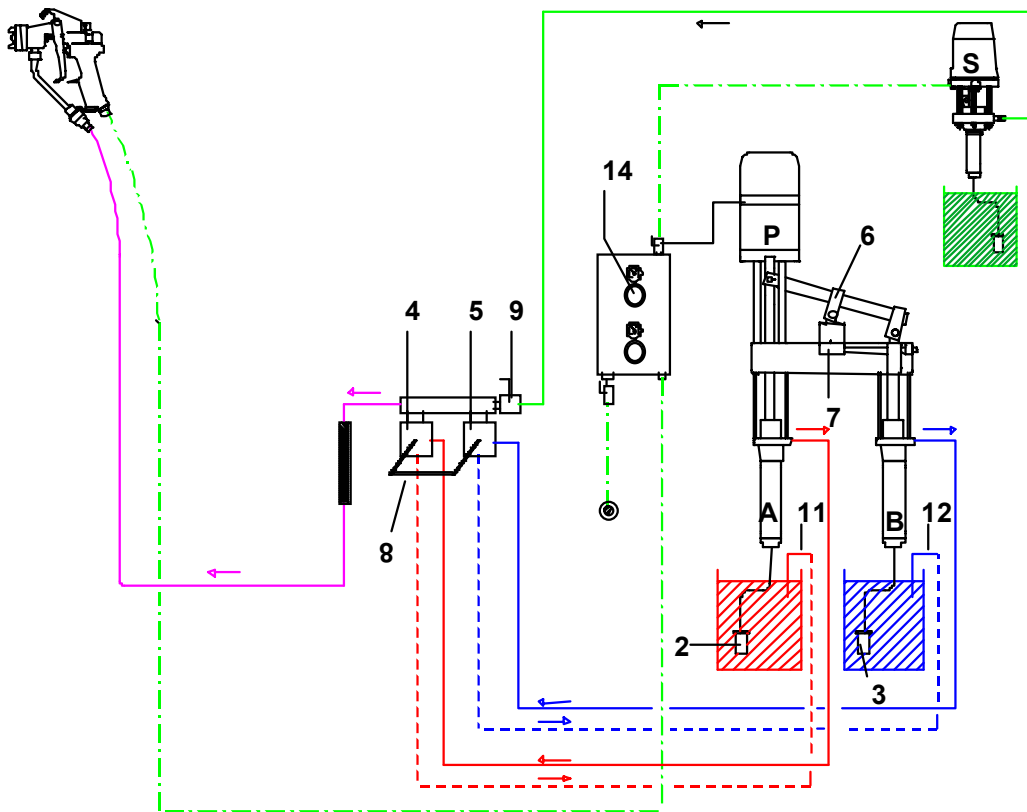

An alternative air motor (P) drives mechanically the piston of BASE fluid section (A).

The BASE is siphoned through suction rod (2) and delivered to valve (4) of the manifold.

Lever-arm (1), coupled to the piston of BASE fluid section (A) drives the piston of CATALYST fluid section (B).

The CATALYST is siphoned through suction rod (3) and drawn into manifold valve (5).

Motion of both fluid sections is synchronous, one cannot move without the other.

The stroke of CATALYST fluid section (B) depends on the location of pivot (6). This position can be modified by moving support (7) manually - thus allowing to obtain the accurate mixing ratio.

■ POSITION OF THE MANIFOLD HAND LEVERS " MIXING/FLUSHING " (8) :

Before moving the hand levers it is compulsory to adjust the air motor regulator to 0 bar.

➔ LOWER position (MIXING) :

BASE and CATALYST are dispensed through mixer where they are thoroughly mixed. Adjust air motor regulator to obtain the desired spraying pressure.

➔ UPPER position (FLUSHING or PRIMING) :

BASE and CATALYST are independently recirculated through drain rods (11 and 12).

To circulate, adjust the air motor pressure on the regulator so that the pump cycles at a cadency of 4 strokes/minute.

If you don't want to circulate, release the air motor pressure on the regulator (14) to 0 bar.

This upper position will enable :



- the priming of the two fluid sections,
- only the flushing of the mixed material circuit (mixer, hose and gun) by opening the "SOLVENT" valve (9),
- the color change in the BASE fluid section.

5. INSTALLATION

The pumps are designed to be installed in a spray booth.

■ DESCRIPTION OF THE LABEL MARKING

Marking in accordance with the ATEX Directive

 KREMLIN KREMLIN REXSON 93240 STAINS FRANCE   II 2G	TYPE	PU 2200
	REFERENCE	151
	DOSAGE-DOSING	/1 → /1
	SERIE.SERIAL	
	P air	6 bar - 87 psi
	P prod	bar - psi

KREMLIN REXSON 93240 STAINS FRANCE	Name and address of the manufacturer
 II 2 G	II : group II 2 : class 2 Surface equipment meant to an area where explosive atmospheres due to gas, vapours, mists or air mixtures with dusts will probably appear. G : gas
TYPE PU 2200	Pump model
REFERENCE	Pump part number : 151.xxx.xxx
DOSAGE-DOSING	Mixture ratio (min-max) : xx/1 → xx/1
Serie / Serial	Number given by KREMLIN REXSON
P air : 6 bar / 87 psi	Air supply maximum pressure of the pump motor.
P prod : xx bar / xx psi	Maximum fluid pressure at the pump outlet.

■ INSTALLATION INSTRUCTIONS

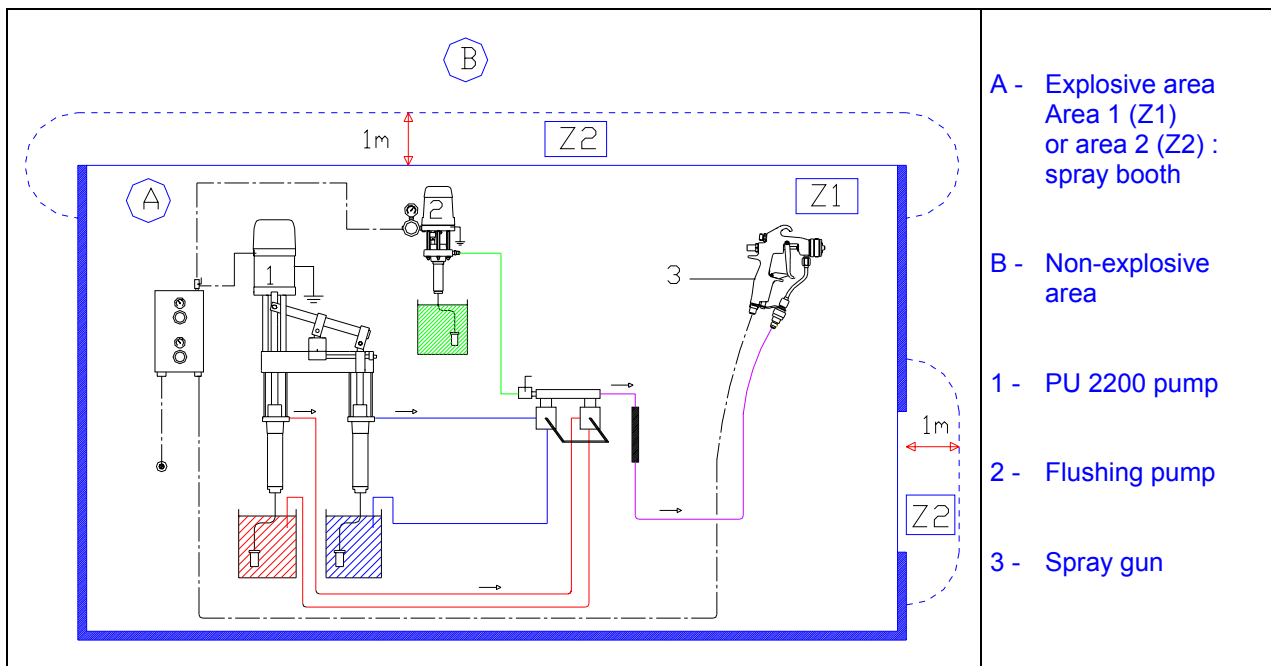

5.1 Suction

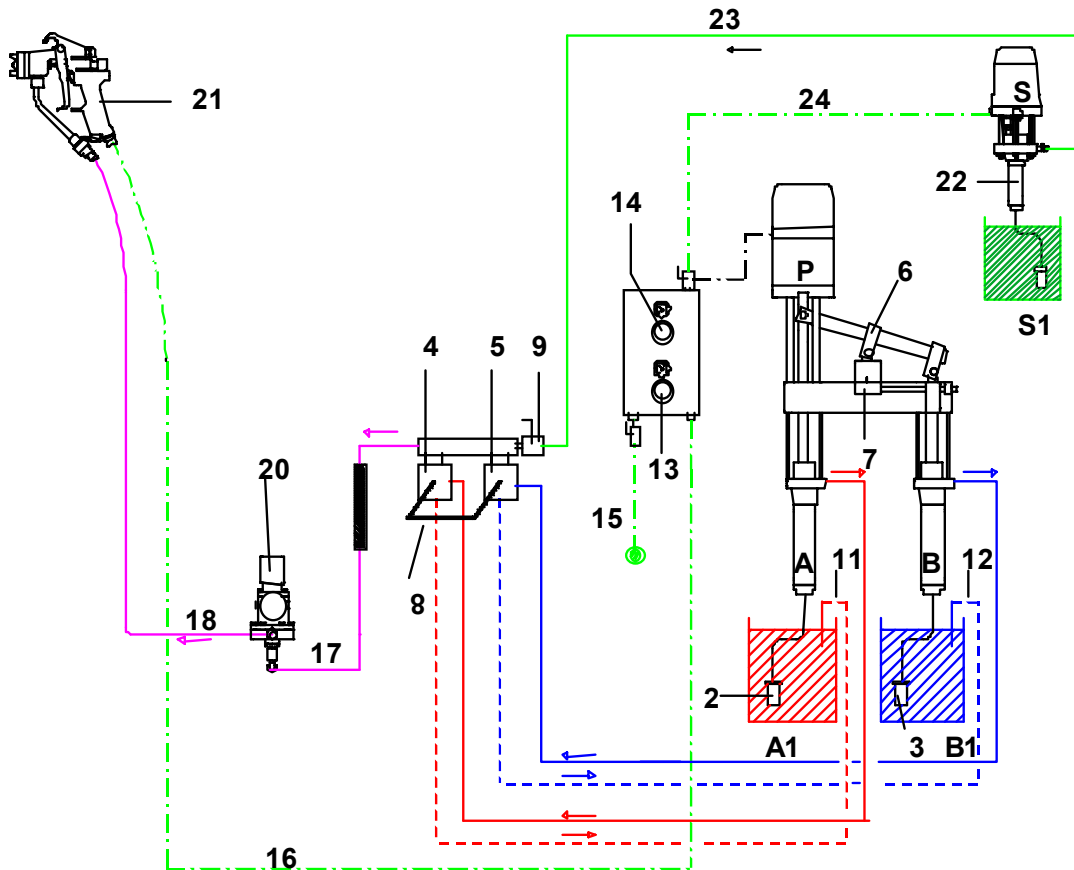

■ PREPARE THE MATERIALS

Fill up a clean container (A1) with BASE (material A).

Fill up a clean container (B1) with CATALYST (material B).

Fill up a container (S1) with cleaning solvent.

■ INTERCONNECTION OF THE HOSES

Air hoses

Connect pump air supply to the compressed air system with a static proof hose (15) - I.D 16 mm / 5/8".

Interconnect air regulator (13) "Atomizing air" to the gun (21) air inlet with a static proof hose (16) (depends upon the gun model used).

Material hoses

• When using a proportioning pump for AIRSPRAY application :

If necessary, install a fluid regulator (20) between the mixer outlet and spray gun (21).

Interconnect the mixer outlet and the inlet of fluid regulator (20) using material hose (17).

Interconnect the outlet of fluid regulator (20) and the inlet of spray gun (21) using material hose (18).

• When using a proportioning pump for AIRMIX® application :

Interconnect the mixer outlet and the inlet of spray gun (21) with material hose.

Nota : these hoses are not included in the standard equipment.

5.2 Filling

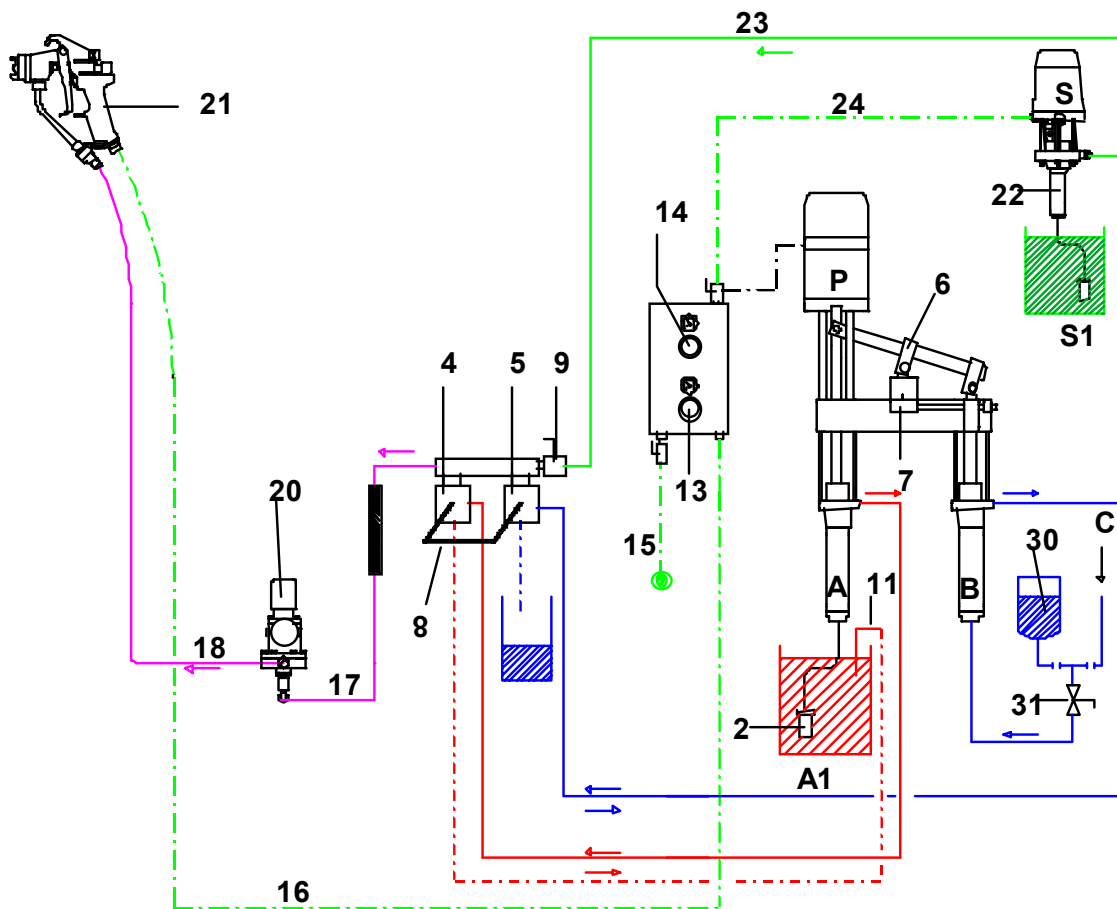

■ PREPARE THE MATERIALS

Fill up a clean container (A1) with BASE (material A).

The CATALYST (material B) comes from a gravity tank (30) or from an external supply (C: Circulating).

Fill up a container (S1) with cleaning solvent.

■ INTERCONNECTION OF THE HOSES

Same installation as the suction one.

■ INSTALLATION: RECOMMENDATION

WARNING:

→ Fluid section filling pressure : 2 bar maximum / 29 PSI max

→ If using a fluid section- model FLOWMAX ®, never use the pump when an isolating gate (31) on the supply circuit is shut: it would damage the bellows.

→ Do not install a material regulator on the supply circuit or any arrangement that could perform as a non-return valve.

■ CONNECTION OF FLUSHING SYSTEM

Install a flushing pump (22).

Interconnect pump (22) and manifold valve (9) using an AIRMIX fluid hose (23).

Interconnect the three way valve (31) located on the air supply unit with the motor air inlet fitting of the flushing pump using an air hose (24).

■ PROPORTIONING ADJUSTMENT

Remove the protective cover to get to the lever-arm.

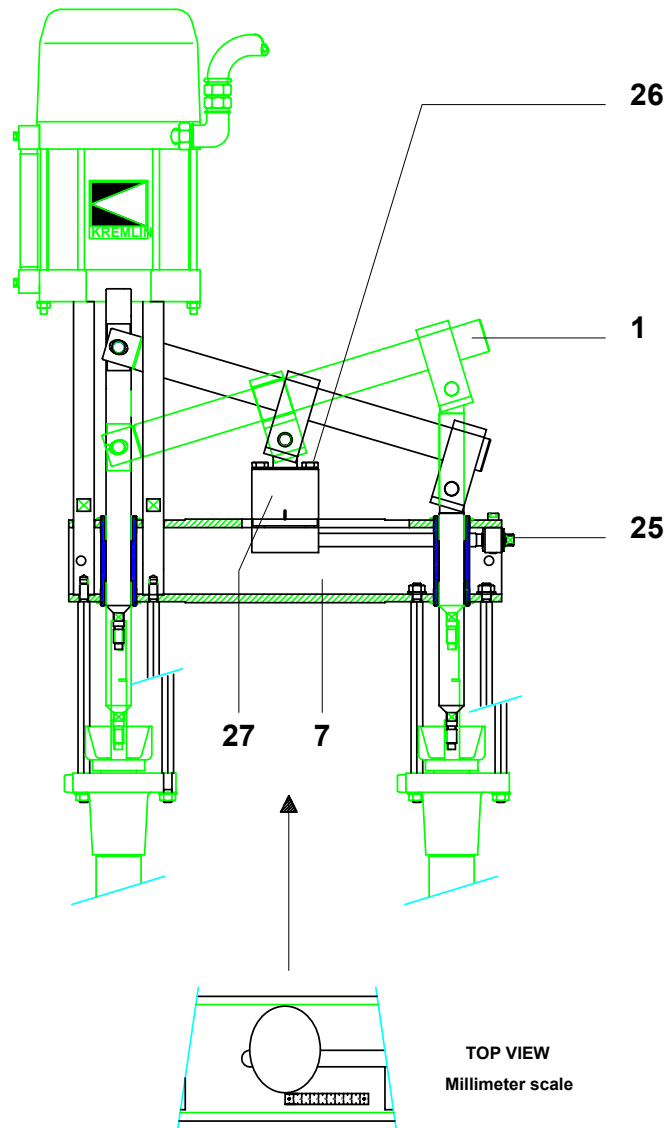

Supply pump motor with compressed air ("air motor" regulator) and adjust the pressure until lever-arm (1) is in the **horizontal position**.

Loosen the screws (26) (from 2 to 3 turns).

With a screwdriver rotate adjusting screw (25) to move part (27) on support (7).

Position part (27) facing the appropriate graduation on the millimeter scale. Refer to comparative table between graduation in millimeter and required mixing ratio according to the fluid sections (see chapter 11).

Tighten screws (26) and reinstall protective cover.

6. START UP

For standard fluid sections, feel up the wetting cup of BASE and CATA fluid section with T lubricant.
For FLOWMAX fluid sections : no prior action is necessary.

Feel up the wetting cup of the flushing pump.

Supply the equipment with compressed air (maxi 6 bar / 87 psi - clean air).

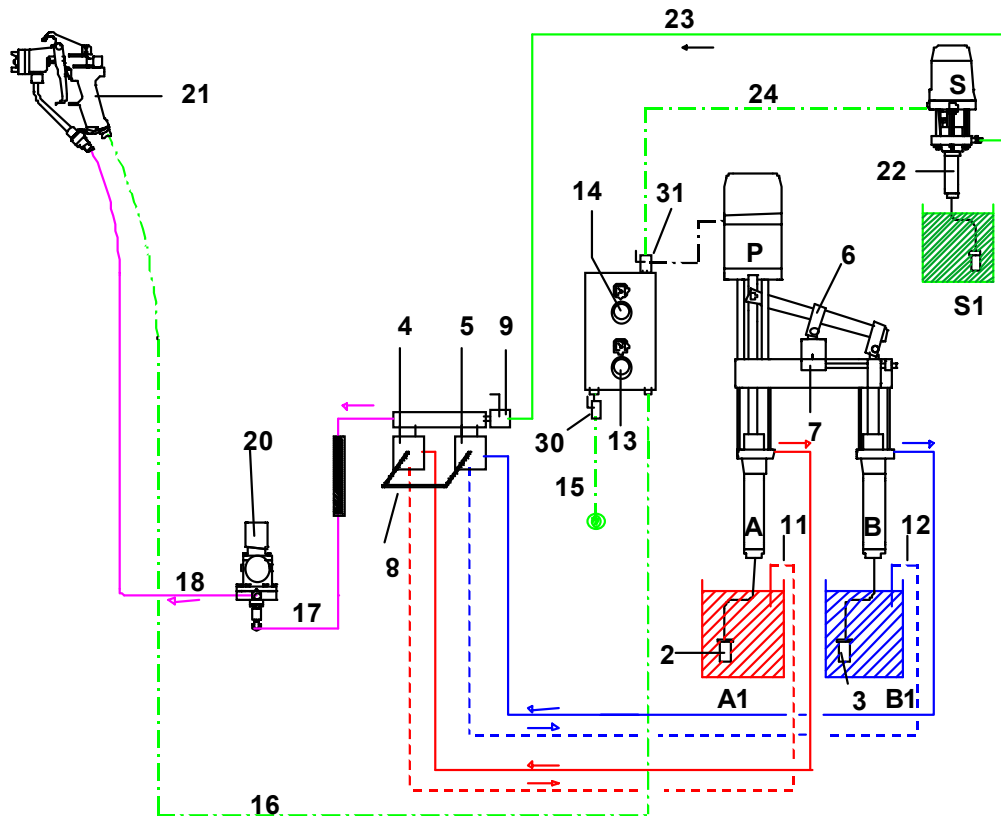

■ PRIMING WITH SOLVENT

This equipment has been checked and tested with D.O.P product in our factory. Before the first start up a complete flushing is required.

- 1 - Be certain the gun trigger is released and air and fluid hoses are properly interconnected.
- 2 - Insert drain rods (11 and 12) into a waste container.
- 3 - Insert suction rod (2) of BASE fluid section into SOLVENT container.
- 4 - Insert suction rod (3) of CATALYST fluid section into SOLVENT container.
- 5 - Be certain the manifold hand levers are in the " **FLUSHING or PRIMING** " position (upper position).
- 6 - Be certain the three way valve (31) is ready to supply with air the proportioning pump motor (three way valve hand lever in a vertical position).
- 7 - Turn upwards the valve hand lever (30) in order to supply with compressed air the box.
- 8 - Adjust the regulator (14) (air motor) between 0.5-2 bar / 7-29 psi.
- 9 - Both components (BASE and CATALYST) must flow freely from the drain rods (11 and 12) into the waste containers.
- 10 - Once drained the circuits, insert each drain rods into their own material container. Then, let the materials circulate until air is evacuated from the fluid circuit.

■ RATIO CHECKING

- 1 - Adjust regulator (14) (air motor) to 0 bar.
- 2 - Insert each suction rod into a graduated beaker.
- 3 - Fill up the two graduated beakers, the one with material A, the other with material B.
- 4 - Be sure that the manifold hand levers are placed in the upper position - FLUSHING or PRIMING position.
- 5 - Immerse drain rods (11 and 12) into clean containers (or into the beakers).
- 6 - Turn the knob of Air motor regulator (14) to obtain a 0.5-2 bar/7-29 psi reading on the gauge.
- 7 - Both components must flow freely from drain rods (11 and 12).
- 8 - Fill up the beakers (if necessary) to prevent the pump from unpriming.
- 9 - With the knob of Air motor regulator (14) adjust air pressure to 0.
- 10 - Move downwards the manifold hand levers, one by one, to **MIXING** position.
- 11 - Turn (clockwise) the knob of Air motor regulator (14) to obtain a 2-4 bar/29-58 psi reading on the gauge.
- 12 - Press the gun trigger for a FEW SECONDS and check the material ALREADY MIXED is coming out from the nozzle freely and thoroughly homogeneous.
- 13 - Install appropriate projector onto the spray gun (according to the desired spraying).
- 14 - Adjust atomizing air pressure with knob of regulator (13).
- 15 - Check the lever-arm is inclined (BASE fluid section piston in the **lower position**).
- 16 - Fill the two beakers with A and B materials at the same level (e.g : 2 litres). Then, press the gun trigger and spray some material.
- 17 - While spraying observe the material level in each beaker : when one of the suction rod strainer appears, release the gun trigger (the BASE fluid section piston being in the **lower position**).
- 18 - Measure BASE and CATALYST volume used.
- 19 - Determine BASE and CATALYST ratio.
- 20 - Compare this result with theoretical ratio.
- 21 - If the calculated ratio is different from the required one, resume proportioning pump priming or make any necessary adjustments of the lever-arm.

■ WORKING

- 1 - With the knob of the Air motor regulator (14) adjust air pressure to 0.
- 2 - Take suction rods out of the beakers and immerse them in their respective containers (materials A and B).
- 3 - Insert each drain rod into A and B containers.
- 4 - Move upwards manifold hand levers to FLUSHING or PRIMING position.
- 5 - Turn the knob of Air motor regulator (14) until to obtain a 0.5-2 bar/7-29 psi reading on the gauge.
- 6 - Let the materials circulate until air is evacuated from the fluid circuit.
- 7 - With the knob of Air motor regulator (14) adjust air pressure to 0.
- 8 - Move downwards the manifold hand levers, one by one, to MIXING position.
- 9 - Turn the knob of Air motor regulator (14) until to obtain a 2-4 bar/29-58 psi reading on the gauge.
- 10 - Adjust atomizing air pressure with knob of regulator (13).
- 11 - Press the gun trigger.

WARNING !

Never invert suction and drain rods (BASE and CATALYST).

The suction and drain rods being different, It is compulsory to immerse them in their own container.

■ **SPRAYING ADJUSTMENT**

Material delivery : Adjust the pressure using the knob of regulator (14).

Atomizing air : Adjust the pressure using the knob of regulator (13).

TROUBLE	CAUSE	SOLUTION
Coating not thick enough	Not enough material.	Increase the material fluid pressure using knob of regulator (Air motor). Spray slower or closer to part being painted. Use the next higher nozzle size.
Sags, runs	Too much material.	Decrease the material pressure using knob of regulator (Air motor). Spray faster or farther from part being painted. Use the next smaller size.
	Distorted spray fan	Refer to gun instruction manual.

■ **COLOR CHANGE (without changing the Catalyst)**

- 1 - Carry out a partial flushing (see chapter 7 - procedures from 1 to 9) to flush the mixed material circuit.
- 2 - Insert drain rod (11) into a waste container.
- 3 - As the three way valve supplies the proportioning pump motor, adjust regulator (14) to the **minimum** working pressure.
- 4 - Drain BASE fluid section and recuperate material in a waste container.
- 5 - Insert suction rod (2) of the BASE fluid section into a solvent container and carry out a flushing.
- 6 - Insert suction rod into the new color container and carry out a priming.
- 7 - Move downwards hand levers of the manifold " MIXING/FLUSHING " (8) to **MIXING** position.

7. FLUSHING

■ **PARTIAL FLUSHING (mixed material circuit)**

- 1 - **Adjust regulator "Air motor " (14) to 0 bar.**
- 2 - Move upwards the three way valve (31) in order to supply with air the motor of the flushing pump (three way valve hand lever in an horizontal position).
- 3 - Move upwards the manifold hand levers - **FLUSHING** position.
- 4 - Adjust regulator "Air Motor" (14) to obtain a pressure between 2-3 bar / 29-44 psi
- 5 - Remove air cap of the airspray gun or the AIRMIX air cap/tip assembly and clean them.
- 6 - Open solvent drain (9) located on the manifold.
- 7 - Point the gun into a waste container and press gun trigger until clean solvent continues to be dispensed through the gun.
- 8 - Turn (counterclockwise) the knob of regulator (14) and close valve (9).
- 9 - Reinstall the projector onto the gun.

Leave the equipment until a next utilization.

■ COMPLETE FLUSHING

- 1 - Carry out a partial flushing (procedures from 1 to 9).
- 2 - Replace BASE and CATALYST containers by containers of clean SOLVENT.
- 3 - Insert suction rods into the solvent containers.
- 4 - Remove air cap or air cap/tip assembly and clean them.
- 5 - Insert drain rods (11 and 12) into waste containers.
- 6 - Be certain the manifold hand levers are in the upper position - FLUSHING position.
- 7- Turn upwards the three way valve (31) to supply with air the proportioning pump motor.
- 8 - Adjust the regulator "Air Motor" to obtain a pressure between 0.5-2 bar / 7-29 psi.
- 9 - Let the solvent flow freely from the drain rods.
- 10 - When the solvent continues to be dispensed clean :
 - With the knob of Air motor regulator (14) adjust air pressure to 0.
 - Insert drain rods (11 and 12) into their own containers.
 - Turn the knob of air motor regulator (14) until to obtain a 0.5-2 bar / 7-29 psi reading on the gauge.
 - Let the solvent circulate for a few minutes.
 - Shut off air supply valve.
 - Reinstall air cap or tip/air cap assembly onto the spray gun.

8. SHUTDOWN AT END OF WORK

Before stopping the spray operation for a period of time longer than the pot-life of the catalyzed material it is necessary to carry out a **PARTIAL FLUSHING**.

For a shutdown at end of day :

- 1 - Check the piston of the CATALYST fluid section stops cycling in the **downstroke** position (except for fluid section type FLOWMAX).
- 2 - Turn knobs (counterclockwise) of regulators (13 and 14) in order to avoid air compressed intake.
- 3 - Press the gun trigger to DEPRESSURIZE the fluid circuit completely.
- 4 - Unscrew retaining-ring and remove air cap/tip assembly for an AIRMIX gun (or air cap only for an Airspray gun). Clean them with a solvent soaked brush. Immerse them into a small solvent container.
- 5 - Move UPWARDS hand levers of the manual selector " MIXING/FLUSHING " (8).
- 6 - Turn upwards the three way valve (31) to supply with air the flushing pump motor.
- 7 - Open solvent inlet valve. Point the gun into a waste container, then press the gun trigger. When the solvent is coming out, keep pressing the gun trigger for about 10 seconds.
- 8 - Reinstall air cap or air cap/nozzle assembly onto the spray gun. Fully screw retaining-ring.
- 9 - Spray some solvent through nozzle to clean it completely.
- 10 - Turn knob of the air regulator (14).Depressurize the system (mixer, hoses and spray gun) but leave the equipment filled up with solvent.
- 11- Shut off the main air supply.

WARNING ! When the proportioning system is not used for an extended period of time - after having thoroughly flushed fluid sections - it is advised to replace materials A and B by D.O.P product. You can reuse this product several times.

It is also necessary to clean suction and drain rods as well as the strainers.

9. SERVICING

The parts in contact with the material will have to be replaced periodically according to the working frequencies and the material being used (abrasive materials for example).

Do not hesitate to replace worn parts, otherwise that could result in the deterioration of the other components.

■ SPRAY GUN

Comply with the usual instructions of spray gun servicing (refer to spray gun manual).

■ PUMP

On standard fluid sections :

- make sure the wetting cup of each pump is always filled up with T lubricant (this T lubricant will normally be coloured by the paint),
- regularly clean the wetting cup with solvent after having drained the lubricant.

Make sure that the suction strainers and rods are clean and in good condition.

Periodically replace the suction strainers.

Be certain hoses are in good condition and showing no evidence of damage.

Periodically disassemble the mixer, clean it or replace the elements.

Flush the pump as often as necessary.

Never inject oil into the compressed air supply.

In case of unexpected shutdown, carry out the FLUSHING procedure immediately (refer to § 7).

With filled up materials, it is necessary to clean the strainer and to circulate the solvent each time it is required. This, according to the quantity and the kind of charge in the material.

CAUTION : when stopping the pump :

- ➔ for a short duration, if the flushing has not been carried out, leave the pump filled up with material,
- ➔ for a long duration, after flushing the pump, leave it filled up with solvent.

10. CHECKING AND TROUBLESHOOTING

■ CHECKING THE TIGHTNESS OF THE PROPORTIONING PUMP FLUID SECTION

The following procedure must be carried out with some solvent.

With the knob of the air motor regulator (14) adjust air pressure to obtain a **MINIMUM WORKING PRESSURE** on the motor of the flushing pump (in order not to damage the pump).

Move upwards the manifold hand levers to DRAIN position.

1 - BASE fluid section checking

When the piston rod in the BASE fluid section is moving upwards, stop it by placing the hand lever of BASE valve (4) in the **MIXING** position - Lower position. (gun trigger is released).

The piston rod (BASE fluid section) should stop in the upstroke :

→ **proper tightness of the exhaust valve and piston seals.**

(Otherwise, replace these parts).

Place the hand lever of BASE valve (4) in the DRAIN position (upper position). The pump restarts cycling.

When the piston rod in the BASE fluid section is moving downwards, stop it by placing the hand lever of BASE valve (4) in the **MIXING** position - lower position. (gun trigger is released).

The piston rod (BASE fluid section) should stop in the downstroke :

→ **proper suction valve tightness.**

(Otherwise, replace this part).

2 - CATALYST fluid section checking

Place both hand levers of valves (4 and 5) in the MIXING position (lower position).

Press the gun trigger to depressurize the circuit and while performing the following operations **keep pressing** the gun trigger.

When the piston rod in the CATA fluid section is moving upwards, stop it by placing the hand lever of CATA valve (4) in the **middle** position.

The piston rod (CATA fluid section) should stop cycling in the upstroke :

→ **proper tightness of the exhaust valve and piston seals.**

(Otherwise, replace these parts).

Place the hand lever of CATA valve (5) in the MIXING position (lower position). The pump restarts cycling.

When the piston rod in the CATA fluid section is moving downwards, stop it by placing the hand lever of CATA valve (5) in the **middle** position.

The piston rod (CATA fluid section) should stop cycling in the downstroke.

→ **proper suction valve tightness.**

(Otherwise, replace this part).

■ TROUBLESHOOTING

1 - When restarting or priming the pump : pump is stalled or there is no fluid delivery from the gun.

Check that :

- the proportioning pump is connected to the compressed air source (P = 6 bar/87 psi).
- the three way valve (30) is ready to supply the proportioning pump motor
- air motor regulator (14) is adjusted between 1-5 bar / 14.5-72.5 psi.
- containers A1 and B1 are filled with materials A and B.
- the hand levers of the manifold valves are placed in the MIXING position.
- the fluid regulator installed upstream from the gun enables a sufficient material pressure (in case of an installation requiring a fluid regulator).

After having performed this checking, recirculate the materials (manifold hand levers placed in the DRAIN position)

- adjust air motor regulator (14) to 0 bar,
- move upwards manifold hand levers to DRAIN position,
- adjust air motor regulator (14) between 0,5- 2 bar / 7-29 psi,
- Each component must flow freely from the drain rods,
In this case, the mixing circuit is clogged. Disassemble the : mixer, mixed material hose, gun tip (and gun filter if an AIRMIX ® gun is used).
Otherwise, check the proportioning pump fluid sections.

2 - When pressing the gun : uneven material fluid delivery from the gun.

- Check material hand levers in containers A1 and B1.
- Carry out a drain procedure to check the proper operation of the fluid sections.

3 - When pressing the gun : no fluid delivery from the gun.

- Perform the procedure described step 2.
- Carry out a partial flushing.

4 - When pressing the gun : spraying trouble.

- Refer to gun instruction manual.

5 - When performing a partial flushing : no solvent delivery from the gun.

Check that :

- flushing pump is supplied with compressed air (three way valve position)
- solvent valve (9) on manifold is open.

After that :

- remove gun air cap/tip assembly (if an AIRMIX ® gun is used),
- remove and clean : mixer, mixed material hose (and gun filter if an AIRMIX ® gun is used).

11. INSTALLATION OF A FLUID SECTION - MODEL FLOWMAX ®

CAUTION : when installing one of the FLOWMAX ® fluid sections listed below :

- Model PU 12,5 F FLOWMAX (P.N° : 144.000.400)
- Model PU 25 F FLOWMAX (P.N° : 144.950.300)
- Model PU 50 F FLOWMAX (P.N° : 144.960.300)
- Model PU 120 F FLOWMAX (P.N° : 144.970.200)

it is **COMPULSORY** to proceed as follow to assure :

- proper assembly,
- reliability and longer working life of the bellows

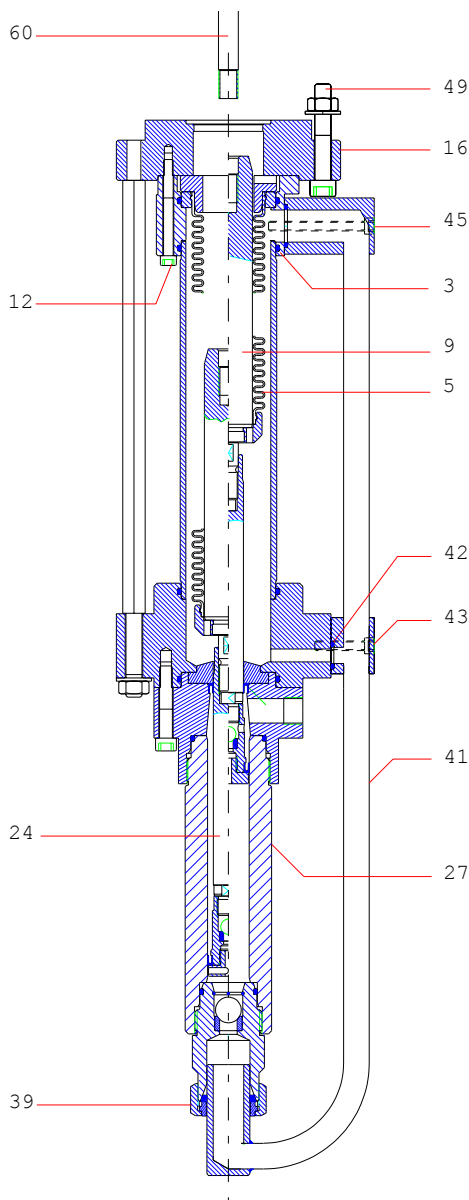

- 1 - Remove fluid attachment tube (41) by unscrewing screws (43 and 45) and loosen nut (39).
- 2 - Unscrew pump cylinder (27) and pull it downward to remove it - therefore you get access to the flats located on pump piston (24).
- 3 - Loosen 3 screws (12) from suction bearing (3) to prevent bellows (5) from distortion when installing the fluid section.
- 4 - Connect lever-arm slider (60) to intermediate fluid section piston (9) by screwing it.
- 5 - Block them using the flats of slider (60) and the flat of fluid section piston (24).
- 6 - Orientate suction flange (16) and secure it with screws (49). **Do not rotate the fluid section piston (24) to orientate suction flange (16).** (Rotate the external part of fluid section assembly).
- 7 - Tighten 3 screws (12) on suction bearing (3).
- 8 - Reinstall pump cylinder (27) and fluid attachment tube (41) in the reverse order of the disassembly.

12. LEVER-ARM ADJUSTMENT - MIX RATIO - PRESSURE RATIO

BASE : 25 cc fluid section

CATA : 12.5 cc fluid section

ADJUST. (mm)	FLUID SECTION		AIR MOTOR			
	25 base	12.5 cata	250-4	500-4	1000-4	
	Mix ratio		Pressure ratio			
0	1,9		8,1	15,5	30,1	
10	2,1		8,2	15,9	30,7	
19	2,3		8,4	16,1	31,2	
27	2,5		8,5	16,4	31,7	
34	2,7		8,6	16,6	32,1	
40	2,9		8,7	16,7	32,4	
47	3,1		8,8	16,9	32,8	
52	3,2		8,9	17,1	33,0	
58	3,4		8,9	17,2	33,3	
63	3,6		9,0	17,3	33,5	
67	3,8		9,1	17,4	33,7	
71	4,0		9,1	17,5	33,9	
75	4,2		9,2	17,6	34,1	
79	4,4		9,2	17,7	34,3	
83	4,6		9,2	17,8	34,4	
86	4,8		9,3	17,9	34,6	
89	5,0		9,3	17,9	34,7	
92	5,2		9,4	18,0	34,8	
95	5,3		9,4	18,0	35,0	
98	5,5		9,4	18,1	35,1	
100	5,7		9,4	18,2	35,2	

BASE : 50 cc fluid section

CATA : 12.5 cc fluid section

ADJUST. (mm)	FLUID SECTION		AIR MOTOR			
	50 Base	12.5 Cata	250-4		1000-4	2000-4
	Mix ratio		Pressure ratio			
0	3,7		5,0		18,6	36,5
10	4,0		5,0		18,7	36,7
18	4,4		5,1		18,8	36,9
26	4,8		5,1		18,9	37,1
34	5,1		5,1		19,0	37,2
40	5,5		5,1		19,1	37,3
46	5,9		5,1		19,1	37,4
52	6,2		5,1		19,2	37,5
57	6,6		5,2		19,2	37,6
62	7,0		5,2		19,3	37,7
67	7,3		5,2		19,3	37,8
71	7,7		5,2		19,3	37,8
75	8,1		5,2		19,4	37,9
79	8,4		5,2		19,4	38,0
83	8,8		5,2		19,4	38,0
86	9,1		5,2		19,4	38,1
89	9,5		5,2		19,5	38,1
92	9,9		5,2		19,5	38,1
95	10,2		5,2		19,5	38,2
98	10,6		5,2		19,5	38,2
100	11,0		5,2		19,5	38,2

LEVER-ARM ADJUSTMENT (CONTINUED)

BASE : 120 cc fluid section

CATA : 12.5 cc fluid section

ADJUST. (mm)	FLUID SECTION		AIR MOTOR			
	120 base	12.5 cata		500-4		2000-4
	Mix ratio		Pressure ratio			
1	8,9			4,2		16,0
10	9,8			4,2		16,0
19	10,6			4,2		16,0
27	11,5			4,2		16,0
34	12,4			4,2		16,0
41	13,3			4,2		16,0
47	14,2			4,2		16,0
53	15,1			4,2		16,1
58	16,0			4,2		16,1
63	16,9			4,2		16,1
67	17,7			4,2		16,1
72	18,6			4,2		16,1
76	19,5			4,2		16,1
79	20,4			4,2		16,1
83	21,3			4,2		16,1
86	22,2			4,2		16,1
90	23,1			4,2		16,1
93	23,9			4,2		16,1
95	24,8			4,2		16,1
98	25,7			4,2		16,1
101	26,6			4,2		16,1

BASE : 25 cc fluid section

CATA : 25 cc fluid section

ADJUST. (mm)	FLUID SECTION		AIR MOTOR			
	25 base	25 cata	250-4		1000-4	
	Mix ratio		Pressure ratio			
0	1,0		5,2		19,2	
10	1,1		5,4		20,1	
18	1,2		5,6		20,9	
26	1,3		5,8		21,7	
33	1,4		6,0		22,4	
40	1,5		6,2		23,0	
46	1,6		6,3		23,6	
52	1,7		6,5		24,2	
57	1,8		6,6		24,7	
62	1,9		6,7		25,1	
67	2,0		6,9		25,6	
71	2,1		7,0		26,0	
75	2,2		7,1		26,4	
79	2,3		7,2		26,7	
82	2,4		7,3		27,1	
86	2,5		7,4		27,4	
89	2,6		7,4		27,7	
92	2,7		7,5		28,0	
95	2,8		7,6		28,3	
97	2,9		7,7		28,5	
100	3,0		7,7		28,8	

LEVER-ARM ADJUSTMENT (CONTINUED)

BASE : 50 cc fluid section

CATA : 25 cc fluid section

ADJUST. (mm)	FLUID SECTION		AIR MOTOR			
	50 base	25 cata	250-4		1000-4	2000-4
	Mix ratio		Pressure ratio			
1	1,9	4,2		15,7	30,8	
10	2,1	4,3		16,0	31,4	
19	2,3	4,4		16,3	31,9	
27	2,5	4,4		16,6	32,4	
34	2,7	4,5		16,8	32,8	
41	2,9	4,5		16,9	33,2	
47	3,1	4,6		17,1	33,5	
53	3,3	4,6		17,3	33,8	
58	3,5	4,7		17,4	34,0	
63	3,6	4,7		17,5	34,3	
67	3,8	4,7		17,6	34,5	
72	4,0	4,8		17,7	34,7	
76	4,2	4,8		17,8	34,9	
80	4,4	4,8		17,9	35,0	
83	4,6	4,8		18,0	35,2	
86	4,8	4,8		18,1	35,3	
90	5,0	4,9		18,1	35,5	
93	5,2	4,9		18,2	35,6	
95	5,4	4,9		18,2	35,7	
98	5,6	4,9		18,3	35,8	

BASE : 50 cc fluid section

CATA : 50 cc fluid section

ADJUST. (mm)	FLUID SECTION		AIR MOTOR		
	50 base	50 cata	250-4		1000-4
	Mix ratio		Pressure ratio		
0	1,0	2,7		10,0	
10	1,1	2,8		10,5	
18	1,2	2,9		10,9	
26	1,3	3,0		11,3	
33	1,4	3,1		11,7	
40	1,5	3,2		12,0	
46	1,6	3,3		12,3	
52	1,7	3,4		12,6	
57	1,8	3,5		12,9	
62	1,9	3,5		13,1	
67	2,0	3,6		13,3	
71	2,1	3,6		13,6	
75	2,2	3,7		13,8	
79	2,3	3,7		14,0	
82	2,4	3,8		14,1	
86	2,5	3,8		14,3	
89	2,6	3,9		14,5	
92	2,7	3,9		14,6	
95	2,8	4,0		14,8	
97	2,9	4,0		14,9	
100	3,0	4,0		15,0	

LEVER-ARM ADJUSTMENT (CONTINUED)

BASE : 120 cc fluid section

CATA : 25 cc fluid section

ADJUST. (mm)	FLUID SECTION		AIR MOTOR			
	120 base	25 cata		500-4		2000-4
	Mix ratio		Pressure ratio			
1	4,6			4,1		15,5
11	5,1			4,1		15,5
19	5,6			4,1		15,6
27	6,0			4,1		15,6
34	6,5			4,1		15,7
41	7,0			4,1		15,7
47	7,4			4,1		15,7
53	7,9			4,2		15,7
58	8,4			4,2		15,8
63	8,8			4,2		15,8
68	9,3			4,2		15,8
72	9,8			4,2		15,8
76	10,2			4,2		15,8
80	10,7			4,2		15,9
83	11,1			4,2		15,9
87	11,6			4,2		15,9
90	12,1			4,2		15,9
93	12,5			4,2		15,9
95	13,0			4,2		15,9
98	13,5			4,2		15,9

BASE : 120 cc fluid section

CATA : 50 cc fluid section

ADJUST. (mm)	FLUID SECTION		AIR MOTOR			
	120 base	50 cata		500-4		2000-4
	Mix ratio		Pressure ratio			
1	2,4			3,6		13,8
10	2,7			3,7		14,0
19	2,9			3,7		14,2
27	3,2			3,8		14,3
34	3,4			3,8		14,4
41	3,6			3,8		14,5
47	3,9			3,9		14,6
53	4,1			3,9		14,7
58	4,4			3,9		14,8
63	4,6			3,9		14,8
68	4,8			3,9		14,9
72	5,1			3,9		15,0
76	5,3			4,0		15,0
80	5,6			4,0		15,1
83	5,8			4,0		15,1
86	6,1			4,0		15,1
90	6,3			4,0		15,2
93	6,5			4,0		15,2
95	6,8			4,0		15,2
98	7,0			4,0		15,3

LEVER-ARM ADJUSTMENT (CONTINUED)

BASE : 120 cc fluid section

CATA : 120 cc fluid section

ADJUST. (mm)	FLUID SECTION		AIR MOTOR		
	120 base	120 cata		500-4	1000-4
	Mix ratio		Pressure ratio		
0	1,0			4,1	
10	1,1			4,3	
18	1,2			4,5	
26	1,3			4,7	
33	1,4			4,8	
40	1,5			5,0	
46	1,6			5,1	
52	1,7			5,2	
57	1,8			5,3	
62	1,9			5,4	
67	2,0			5,5	
71	2,1			5,6	
75	2,2			5,7	
79	2,3			5,8	
82	2,4			5,8	
86	2,5			5,9	
89	2,6			6,0	
92	2,7			6,0	
95	2,8			6,1	
97	2,9			6,1	
100	3,0			6,2	