



INSTRUCTION MANUAL
AIRMIX® AUTOMATIC SPRAY GUN

Manual : 0802 573.013.212

Date : 4/02/08 - Supersede : 18/09/06

- Modif.: Update

KREMLIN REXSON – 150, avenue de Stalingrad
93 245 - STAINS CEDEX - FRANCE
Téléphone : 33 (0)1 49 40 25 25 Télécopie : 33 (0)1 48 26 07 16



INSTRUCTION MANUAL
AIRMIX® AUTOMATIC SPRAY GUN

SUMMARY

1.	EC DECLARATION OF CONFORMITY.....	2
2.	WARRANTY	2
3.	SAFETY INSTRUCTIONS	3
4.	AIRMIX® ATOMIZATION PRINCIPLE	6
5.	INSTALLATION.....	6
6.	OPERATION.....	8
7.	GUN HANDLING	8
8.	DAILY MAINTENANCE.....	8
9.	TROUBLESHOOTING CHART.....	9

The specifications of the gun - features and maintenance - are available in a documentation enclosed to the manual.

Dear Customer,

We thank you very much for purchasing the new **Airmix** ® gun.

To make sure your investment will provide full satisfaction, special care has been taken by KREMLIN during all designing and manufacturing processes.

To get the best result, safe and efficient operation of your spray gun, we advice you to read and make yourself familiar with this instruction and service manual. Indeed, the non-compliance with instructions and precautions stated in this manual could reduce the equipment working life, result in operating trouble and create unsafe conditions.

1. EC DECLARATION OF CONFORMITY

The manufacturer : **KREMLIN REXSON** with assets of 6 720 000 Euros

Head office : 150, avenue de Stalingrad 93 245 - STAINS CEDEX - FRANCE

Tel. 33 (0)1 49 40 25 25 - Fax : 33 (0)1 48 26 07 16

Herewith declares that : Spray gun, is in conformity with :

EC - Machinery Directive (Directive 98/37/EC) as amended and with national implementing legislation.

Ex - ATEX Directive (Directive 94/9/EC) :  II 2 G (group II, class 2, gas).

Established in Stains, on March 1st 2003,

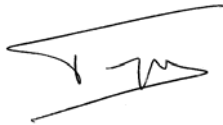

Daniel TRAGUS
President

2. WARRANTY

We reserve the right to make changes; these changes may be carried out after the receipt of our order. No claim will be accepted as a consequence of any change carried out in the instruction manuals or in the selection guides.

Our equipment is checked and tested prior to shipment. In the case of a problem arising with the equipment, this must be in writing, within ten days from the delivery date.

KREMLIN REXSON warrants all equipment manufactured bearing its name, to be free from defect in material or workmanship for a period of 12 months (one shift per day or 1800 hours - 1 term reached) from the date of delivery. Work life is based on single shift working - 8 hours per day. Warranty claims for defective items will only be accepted in writing and will be verified and confirmed by us.

The warranty does not cover fair wear tear, damage or wear caused by misuse, improper maintenance or non-observance of our recommendations.

KREMLIN REXSON will repair or replace parts (carriage paid to our plant and accepted as defective by us). We shall not be liable for any losses, resulting from a production breakdown. Upon request, we can carry out service work at your premises; all expenses (travelling and accommodation) for KREMLIN REXSON technicians will be chargeable.

In the event that it is found that equipment has been tampered with, this will invalidate the warranty. Equipment that is bought in will be subject to the supplier's warranty.

3. SAFETY INSTRUCTIONS

GENERAL SAFETY INSTRUCTIONS



CAUTION : The equipment can be dangerous if you do not use it according to the rules mentioned in this instruction manual. Read carefully all the instructions hereafter before operating your equipment.

Only trained operators can use the equipment. (To acquire an essential training, please contact the "KREMLIN REXSON University" training center - Stains).

The foreman must ensure that the operator has perfectly taken in the safety instructions of this equipment as well as the instructions in the manuals of the different parts and accessories.



















Read carefully all instruction manuals, label markings before operating the equipment.

Incorrect use may result in injury. This equipment is for professional use only. It must be used only for what it has been designed for. Never modify the equipment. The parts and accessories supplied must be regularly inspected. Defective or worn parts must be replaced.

Never exceed the equipment components' maximum working pressure.

Comply with regulations concerning safety, fire risks, electricity in force in the country of final destination of the material. Use only products or solvent compatible with the parts in contact with the material (refer to data sheet of the material manufacturer).

PICTOGRAMS

					
NIP HAZARD	WARNING MOVING ELEVATOR	WARNING MOVING PARTS	WARNING MOVING SHOVEL	DO NOT EXCEED THIS PRESSURE	HIGH PRESSURE HAZARD
					
RELIEF OR DRAIN VALVE	WARNING HOSE UNDER PRESSURE	WEAR GLASSES OBLIGATORY	WEAR OF GLOVE IS OBLIGATORY	PRODUCT VAPOR HAZARDS	WARNING HOT PARTS OR AREAS
					
ELECTRICAL HAZARD	WARNING FIRE HAZARDS	EXPLOSION HAZARDS	GROUNDING	WARNING (USER)	WARNING SERIOUS INJURIES

PRESSURE HAZARDS



Current legislation requires that an **air relief** shut off valve is mounted on the supply circuit of the pump motor to let air off when closing the supply circuit. Without this precaution, the motor residual air of the motor may let the pump beat and cause a serious injury.

Please ensure that, a **material drain valve** is mounted on the material circuit to drain it (after shutting down air to the motor and the pressure relief) before any servicing on the equipment. These valves must be closed for air and opened for product when processing.

HIGH PRESSURE INJECTION HAZARDS

When working with high pressure equipment, special care is required. Fluid leaks can occur. Then there are injection risks in exposed parts of body that may cause severe injuries or amputations :



- Medical care must be handled immediately if product is injected under the skin or in other parts of the body (eyes, fingers).
- Never point the spray gun at any one. Never try to stop the spray with your hands or fingers nor with rags or similars.
- **Follow the shut down procedure and always depressurize air and fluid circuits** before carrying out any servicing on the gun (cleaning, checking, maintenance of the material or cleaning of the gun nozzles).
- For the guns equipped with a safety device, always lock the trigger when you do not start the gun.

FIRE - EXPLOSION - SPARKS - STATIC ELECTRICITY HAZARDS

A poor earth connection, inadequate ventilation, sparks or static electricity can cause an explosion or fire. to avoid these risks when using or servicing KREMLIN REXSON equipment, the following safety procedures must be followed :



- ensure a good earth connection and ground the parts to be handled i.e. solvents, materials, components and equipment,
- ensure adequate ventilation,
- keep working area clean and free from waste solvents, chemicals, or solid waste i.e. rags, paper and empty chemicals drums,
- never use electrical switches / power if in an atmosphere of volatile solvent vapour,
- stop working immediately in case of electrical arcs,
- never store chemicals and solvents in the working area,
- use paint whose flash point is the highest possible to prevent from any formation of gas and inflammable vapours (refer to materials' safety instructions),
- install a cover on the drums to reduce the diffusion of gas and vapours in the spraybooth.

TOXIC PRODUCT HAZARDS

Toxic products or vapours can cause severe injury not only though contact with the body, but also if the products are ingested or inhaled. It is imperative :



- to know the material products and their risks,
- notified or hazardous materials must be stored in accordance with the regulations,
- the material must be stored in an appropriate container, never place materials in a container where there is a risk o spillage or leakage,
- a procedure must be applied for the safe disposal of waste material. It must comply with all prevailing regulations and legislations of the country where the equipment is to be used,
- protective clothing should always be worn in compliance with the material manufacturers' recommendations,
- depending on the application and chemical safety instructions, safety glasses, gloves, foot wear, protective masks and possible breathing equipment should be worn to comply with the regulations

(Refer to chapter "Safety equipment of KREMLIN selection guide).



CAUTION!

It is forbidden using any solvent or with halogenated hydrocarbon base and also products with these solvents facing **aluminium** or **zinc**. The non-compliance with the instructions may cause explosion hazards causing serious or fatal injuries.



EQUIPMENT REQUIREMENTS

PUMP

Before carrying out any work, it is imperative to get used with the compatibilities of motors with pumps before coupling. The operator shall understand the equipment and the safety instructions. These instructions are available in the manuals of the pumps.



The air motor is designed to be mounted with a pump. Never modify any components or couplings. Where operating, please keep hands away from moving parts. Before starting up the equipment, please read the PRESSURE RELIEF instructions. Please ensure that any relief or drain valves fitted are in good working order.



HOSES

- Keep hoses out of circulation areas, moving parts or hot surfaces,
- Never expose product hoses to temperature higher than + 60°C / 140° F or lower than 0°C / 32° F,
- Never pull or use the hoses to move the equipment,
- Tighten all fittings as well as the hoses before operating the equipment,
- Check the hoses regularly; change them if they are damaged,
- Never exceed the working pressure (WP) indicated on the hose.

USED PRODUCTS

Considering the variety of products that may be used by the users and the impossibility to check off all chemical data, of possible reactions of chemicals to each other and their long term evolution, KREMLIN REXSON can not be considered as liable for :

- the bad compatibility of wetted parts,
- risks for staff and surroundings,
- for worn or out of order parts, for wrong working of equipments or units, as well as for the qualities of final product.

The user must know and prevent the possible risks as toxic vapours, fires or explosions due to used products. He shall determine the risks of immediate reactions or pursuant to repeated exposures of the staff,

KREMLIN REXSON shall not be liable for psychic injuries, direct or indirect material damages further to the use of chemicals.

4. AIRMIX® ATOMIZATION PRINCIPLE

The spray air cap of the AIRMIX ® gun is composed of 2 functional elements : a spray tip and an air cap. Atomization takes place in two phases :

1. The fluid is pre-atomized by going through the spray tip under pressure.
2. Atomization is improved by means of very low pressure atomizing air jets.

The end results is a fine uniform atomization that guarantees an excellent finish without excessive overspray. This results in very important air and fluid savings and cleaner working conditions - in comparison with a conventional air spray gun.

5. INSTALLATION

■ DESCRIPTION OF THE LABEL MARKING

Marking in accordance with the ATEX directive

(example : AVX gun label)

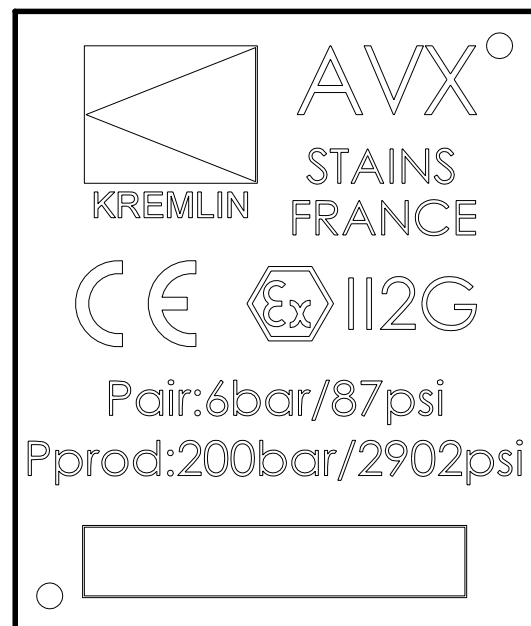

KREMLIN STAINS FRANCE	Name and address of the manufacturer
AVX	Gun model
CE  II 2 G	II : group II 2 : class 2 Surface equipment meant to area where explosive atmospheres due to gas, vapours, mists are liable to appear from time to time in usual operating. G : gas
P air : 6 bar / 87 psi	Gun air supply maximum pressure
P prod : 200 bar / 2902 psi	Maximum fluid pressure

■ **INSTALLATION INSTRUCTIONS**

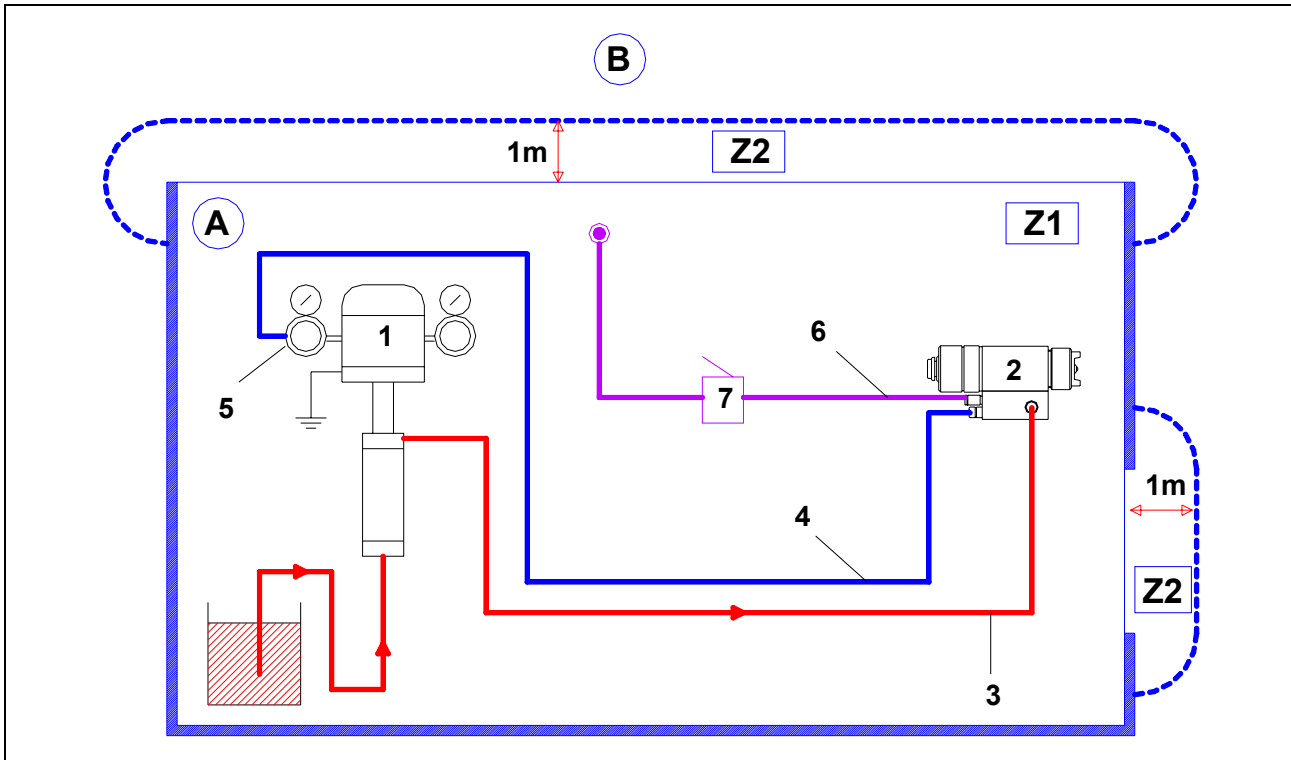

Captions :

A	Explosive area area 1 (Z1) or area 2 (Z2) : spray booth
B	Non-explosive area
1	Pump
2	Airmix ® automatic gun

3	Conductive HP fluid hose
4	Air hose (spraying air)
5	Air regulator
6	Air hose (control air)
7	3-way valve or electrovalve

- 1 - With a **conductive high pressure** hose (3), connect the gun fluid fitting to the pump. The fittings must be firmly tightened.
- 2 - By means of an air hose (4), connect the gun "Spraying air" fitting (2) to an air regulator that can supply at least 3 bar / 43.5 psi (→ spraying air).
- 3 - By means of an air hose (6), connect the gun "Control air" fitting to the valve or the electrovalve (7) that can controls the opening and the closing of the gun.

A minimum pressure of 3 bar / 43.5 psi or 4 bar / 58 psi is necessary to the gun control (→ control air).



Nota : In some particular cases, if the fluid hose (3) is a non-conductive hose, the air hose (4) must be conductive.

One of the 2 hoses (air or fluid) of the gun must be conductive.

6. OPERATION

- 1 - Prime the pump.
 - 2 - Unscrew the air adjuster on the base of the gun.
 - 3 - Select a spray tip (refer to AIRMIX® spray tip chart).
 - 4 - Make sure white seal (or micro-filter) is in place in the spray tip.
 - 5 - Carefully press the spray tip into the air cap back being certain the locating pins are aligned with mating recesses of the tip.
 - 6 - Insert the air cap with its tip into the retaining ring. Screw retaining ring and air cap firmly onto the spray gun positioning the air cap to obtain the desired pattern orientation.
 - 7 - Adjust the air pressure for the desired flow rate.
 - 8 - If tails or heavy deposits of sprayed material occur at the ends of the pattern, increase the atomizing air pressure until the pattern is even.
 - 9 - If using an adjustable air cap, pattern width can be optimized with the air adjusting knob.
- Nota : if more material or less material are required, select another spray tip (refer to AIRMIX® spray tip chart).

7. GUN HANDLING

When mounting the air cap on the gun, hold it vertically in order to correctly adjust the air cap before screwing the air cap ring.

Keep the gun perpendicular to the surface to be painted.

Do not forget that crossed sweeps cannot correct irregularities.

Spraying from a stationary gun will not give even coverage.

Make sure that overlapping from the passes is even (gun moving vertically, part moving horizontally).

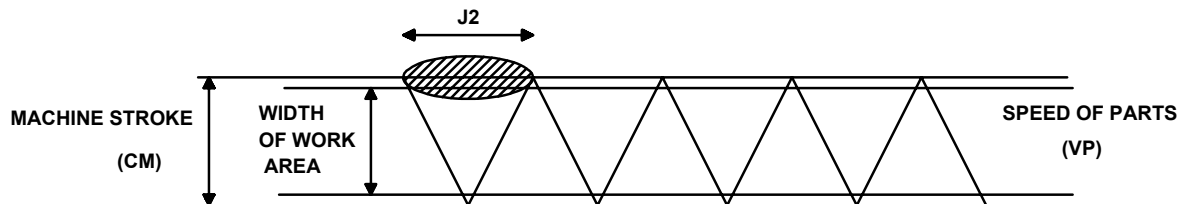

This width J2 for two regular coats of paint corresponds exactly to the following formula :

$$J2 \text{ (m)} = VP \text{ (m/s)} \times 2 \frac{CM \text{ (m)}}{VM \text{ (m/s)}}$$

Where :

VP = speed of travel of the parts to be painted.

CM = total stroke of the machine (and therefore of the spray guns).

VM = speed of the machine (and therefore of the spray guns).

2 = 2 regular coats of paint (or 4 if you want to double the number of coats).

8. DAILY MAINTENANCE

Do not use fluid which would quickly clog the filter or would often block the spray tip.

Air supply should be clean.

The gun is a precision instrument and it relies on good and frequent maintenance for its correct operation.

When it is carried out directly after use, the cleaning of the gun is faster and easier.

Never use metal brushes files, points or clips for dismantling.

Whenever possible, during the course of the day, clean the outside of the spray tip with a soft brush.

Use a tip unclogging needle of the proper size.

▪ **SHORT DURATION SHUTDOWN (LESS THAN 3 HOURS)**

Remove the paint on the air cap with a brush and solvent. Otherwise, leave the equipment as it is. Removing the paint will prevent the drying and clogging of the holes.

▪ **LONG DURATION SHUTDOWN**

Depressurize the fluid systems.



Unscrew the air cap. Remove the spray tip and soak it in solvent. Use a tip unclogging needle of the proper size.

Flush the installation and leave it full of solvent.

➡ **Never soak the gun in solvent.**

➡ **Always make sure white seal or micro-filter are in place in the spray tip.**

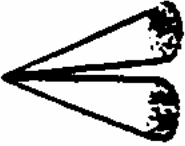
9. TROUBLESHOOTING CHART

TROUBLE	CAUSE	SOLUTION
No fluid out of the gun.	Tip is blocked.	Shut off pressure on pump. Depressurize the hoses. Remove and clean spray tip and filter.
Low flow rate.	Filter is partially clogged.	
Spray fan is not uniform. 	Tip is partially clogged.	
Spray fan is not uniform. 	Air holes in air cap are partially blocked.	Remove and clean with solvent. Blow all air holes clear with compressed air.
Excessive fluid fog.	Too much atomizing air.	Reduce atomizing air with the air regulator.
Pattern width narrows during reversing phase of pump.	Air trapped in the fluid circuit. Viscosity too high.	Check connection and suction hose quality. Reduce viscosity.
Air cap becomes dirty frequently.	Too much air. Seat-holder leaking.	Reduce air pressure. Replace it
Fluid seeping from the air holes of the air cap.	Defective tip seal. Retaining ring loose.	Replace it. Tighten it.
Fluid leak through leakage detector.	Cartridge worn	Replace cartridge .
No change in pattern width.	Air leak in front of the gun.	Replace air adjuster.